

# Ceiling System Wine Cellar Cooling Units

Installation, Operation and Maintenance Guide

Model CS025, CS050 (60Hz)

Model WGC60 (50Hz)

Manufactured by:



[wineguardian.com](http://wineguardian.com)

[airinnovations.com](http://airinnovations.com)

Wine Guardian reserves the right, without notice, to make changes to this document at its sole discretion.  
Please visit our web site for the most current version of the Wine Guardian manual and other literature.

Wine Guardian is a registered trademark (2,972,262) of Air Innovations, Inc.

Condensing Unit Patent No. U.S. D791295, EU 003189349-0001

Edition 03-2021

© Air Innovations, 2021 Part# 15H0269-00 REV A

## **Table of Contents**

<i>Directory of Terms</i> .....	6
<i>Receiving, Inspecting and Unpacking the Wine Guardian Unit</i> .....	8
Check for the following contents .....	8
<i>General Description</i> .....	9
The Wine Guardian Ceiling System Contains.....	9
Wine Guardian Ceiling Fan Coil Unit.....	11
Electrical Controls.....	11
Condensing Unit.....	12
Accessories and Optional Equipment.....	12
Extended Compressor Warranty.....	12
Remote sensors.....	12
Heating Coils.....	12
Humidifier .....	12
Xtreme Low Ambient (see illustrations on following page) .....	13
Xtreme Low Ambient Illustrations.....	14
Overview of the Wine Guardian Ceiling Fan Coil System .....	15
Wine Guardian dimensions for Ceiling Systems CS025, CS050, WGC60.....	15
Condensing unit dimensions .....	16
Refrigeration Illustration of the system.....	17
Magnified Image of the Condensing Unit.....	18
Wiring Diagram for CS025 & CS050 .....	19
Wiring Diagram for WGC60.....	20
Wiring Diagram for DS025 and WGS40 Condensing Unit .....	21
Wiring Diagram for DS050 and WGS75 Condensing Unit .....	22
Ceiling System Specifications - 60Hz/50Hz Models CS025, CS050, & WGC60 .....	23
<i>Safety</i> .....	24
Safety Message Conventions.....	24
Danger .....	24
Warning.....	24
Caution .....	24
Lockout/Tagout Procedure .....	25
Safety Considerations.....	25
Safety Hazards.....	25
Electrical Hazards.....	25
Electrical Shock Hazards.....	25
Hot Parts Hazards .....	25
Moving Parts Hazards .....	25
Equipment Safety Interlocks .....	26

Main Power Switch .....	26
<b><i>Installation.....</i></b>	<b>28</b>
Prior to installation check system for non-visible shipping damage. ....	28
<b><i>Planning the Installation .....</i></b>	<b>29</b>
Addressing Items in the Planning Process.....	29
Performing a Pre-Installation Check .....	29
<b><i>Installing the Ceiling Fan Coil unit.....</i></b>	<b>30</b>
<b><i>Installing the Condensate Drain Connection .....</i></b>	<b>36</b>
Installing the Drain Line.....	36
Priming the Condensate Pump .....	36
<b><i>Refrigerant piping Swagelok connection Installation Instructions .....</i></b>	<b>36</b>
<b><i>Wiring the Fan Coil Unit for Power.....</i></b>	<b>39</b>
<b><i>Installing the Condensing Unit .....</i></b>	<b>40</b>
Installation of Interconnecting Refrigerant Lines (Suction and Liquid) .....	40
Split System Interconnecting Line Sizing Chart .....	41
Sample Piping Configurations.....	42
Leak Checking and Evacuation Process.....	43
Wiring.....	43
Refrigerant Charging .....	45
Determining the amount of charge.....	45
Procedures for Charging System with Head Pressure Control.....	45
Superheat.....	47
Sub-Cooling .....	47
System Charging Amount .....	<b>Error! Bookmark not defined.</b>
Split System Operations Chart .....	47
<b><i>Installing the Thermostat and Communication Cable.....</i></b>	<b>50</b>
<b><i>Controller Specification .....</i></b>	<b>51</b>
<b><i>Mounting the Remote Interface Controller (Wired).....</i></b>	<b>52</b>
<b><i>Mounting the Remote Interface Controller (Wireless) .....</i></b>	<b>53</b>
<b><i>Installation of the Wine Guardian Remote Sensor .....</i></b>	<b>54</b>
Mounting the Wired Remote Sensor (Wired) .....	54
Mounting the Remote Sensor (Wireless) .....	56
<b><i>Remote Sensor Pairing Instructions –Multiple Sensors (Wireless).....</i></b>	<b>57</b>
<b><i>Standard Controller Functions .....</i></b>	<b>58</b>
Alarm Codes.....	65
<b><i>Inspection and Start Up Checklists .....</i></b>	<b>67</b>
Receiving and Inspecting .....	67
Handling and Installing .....	67
Starting-up the Unit.....	67

<i>WG Split system start-up checklist</i> .....	68
<i>Starting-up and Operating the Wine Guardian Split System</i> .....	70
Turn on the Unit .....	70
Testing the Fan .....	70
Running the Unit .....	70
Cycling the Unit .....	71
Setting the Remote Interface Controller.....	71
Regulating the Wine Cellar Temperature.....	71
<b><i>Maintenance</i></b> .....	<b>72</b>
General .....	72
Cleaning the Condensate Drain System .....	73
Cleaning the Humidifier .....	74
Heating Coil Option .....	74
<b><i>Maintenance Schedule</i></b> .....	<b>75</b>
Monthly .....	75
Yearly.....	75
<b><i>Troubleshooting</i></b> .....	<b>76</b>
Typical start up problems .....	76
Unit does not start up.....	76
<i>Unit is operating and blows evaporator air but the supply air is not colder than the return air from the cellar</i> .....	77
Humidity Issues.....	78
<i>Too low, without optional humidifier</i> .....	78
<i>Humidity too low, with optional humidifier</i> .....	78
<i>Humidity too high when unit is running but not cooling</i> .....	78
<i>Humidity too high when unit is not running</i> .....	78
<i>Humidity too high when unit is running and cooling</i> .....	78
Unit is leaking water.....	79
Unit is running properly, but the sound of the unit objectionable .....	79
High Pressure Switch has Shut the Unit Down .....	79
Instructions to Reset High Pressure Switch.....	79
<b><i>Advanced Troubleshooting</i></b> .....	<b>80</b>
Evaporator Coil is Freezing.....	80
Unit cycles on and off more than 8 times/hr .....	80
Replacing the blowers .....	80
<b><i>Contact and Warranty Information</i></b> .....	<b>81</b>
<b><i>Warranty</i></b> .....	<b>82</b>

Note: This equipment has been tested and found to comply with the limits for a Class B digital device, pursuant to part 15 of the FCC Rules. These limits are designed to provide reasonable protection against harmful interference in a residential installation. This equipment generates, uses and can radiate radio frequency energy and, if not installed and used in accordance with the instructions, may cause harmful interference to radio communications. However, there is no guarantee that interference will not occur in a particular installation. If this equipment does cause harmful interference to radio or television reception, which can be determined by turning the equipment off and on, the user is encouraged to try to correct the interference by one or more of the following measures:

- Reorient or relocate the receiving antenna.
- Increase the separation between the equipment and receiver.
- Connect the equipment into an outlet on a circuit different from that to which the receiver is connected.
- Consult the dealer or an experienced radio/TV technician for help.

#### RSS GEN (English)

This device contains licence-exempt transmitter(s)/receiver(s) that comply with Innovation, Science and Economic Development Canada's licence-exempt RSS(s). Operation is subject to the following two conditions:

1. This device may not cause interference.
2. This device must accept any interference, including interference that may cause undesired operation of the device.

#### RSS GEN (French)

L'émetteur/récepteur exempt de licence contenu dans le présent appareil est conforme aux CNR d'Innovation, Sciences et Développement économique Canada applicables aux appareils radio exempts de licence. L'exploitation est autorisée aux deux conditions suivantes :

1. L'appareil ne doit pas produire de brouillage;
2. L'appareil doit accepter tout brouillage radioélectrique subi, même si le brouillage est susceptible d'en compromettre le fonctionnement.

## Directory of Terms

**Ambient Air** – The surrounding area outside the wine cellar such as a room, basement, garage or outdoors.

**BTU/H** – British thermal units/hour. A unit of measurement to describe the power of heating and cooling system.

**CFM** – Cubic feet per minute. A unit of measurement for the amount of air handled by the fan.

**Condensate / Condensation** – The water formed out of the air when it is cooled below a certain temperature (called dew point). Often referred to as “sweating” on pipes and cold surfaces. This water collects at the bottom of the evaporator or cooling coil and drains out of the unit through the drain line.

**Condensing Unit (Heat Rejection)** – The condensing unit uses the compressor, condenser coil and fan to remove heat from the refrigerant to the ambient air *outside* the wine cellar. The word condenser refers to the condensation of the refrigerant from gas to liquid phase.

**CSA/ETL** – Canadian Standards Association/Edison Testing Laboratory (product compliance to safety standards)

**F** – (Degrees) Fahrenheit

**Ceiling Mounted Fan Coil Unit (Evaporator Cooling)** – The fan coil unit uses the cooling coil and the fan to remove heat from the air *inside* the wine cellar to the refrigerant, cooling the air and condensing moisture out of the air. The word evaporator refers to the evaporation of the refrigerant from liquid to gas phase in the coil. The fan coil unit is ducted to or can be placed inside the wine cellar.

**Flexible Duct** – Round ducts with steel reinforced plastic liners, a layer of insulation and an outer plastic layer used to convey the air from the unit to the wine cellar or ambient space.

**Grille or Diffuser** – Inlet or outlet plates to direct the airflow or protect the inside of the unit.

**Heat Gain / Loss** – The amount of cooling or heating expressed in watts transferred between the wine cellar and the ambient space. The Wine Guardian must offset this heat/gain loss.

**Inlet Air** – The air returning from the wine room to the Wine Guardian fan coil.

**I.D.** – Inside diameter

**NEC** – National Electrical Code

**O.D.** – Outside diameter

**Psig Pounds** – Force per square inch gauge

**Recovery** – The amount of cooling the unit does to return the cellar to its set point temperature after some new heat load is introduced, such as people or new cases of warm wine entering the cellar.

**Return Air** - The air leaving the cellar and returning to the inlet of the fan coil. (See Inlet Air above)

**TXV** – Thermal expansion valve

**VAC** – Volts alternating current

**SP** – Static pressure. Unit of measurement (inches of water column) of the pressure of the air handled by the fan.

**Set Point** – The desired temperature or humidity set on the remote interface controller or humidistat.

**Supply Air** - The air entering the wine cellar from the discharge of the fan coil.

## Receiving, Inspecting and Unpacking the Wine Guardian Unit

***NOTE: Wine Guardian units are factory assembled and tested prior to shipment. The Wine Guardian Ducted Split System consists of two separate components, the Wine Guardian fan coil and condensing unit.***

Each Wine Guardian component is shipped in a corrugated box. A shipment may include one or more boxes containing accessories.

- ✓ Lift at the designated handhold locations only or fully support from underneath.
- ✓ Before opening, inspect the packing crates or boxes for obvious signs of damage or mishandling.
- ✓ Write any discrepancy or visual damage on the bill of lading before signing.
- ✓ Inspect all equipment for any sign of damage caused during transit.
- ✓ Report all visual or concealed damage to the carrier and file a claim immediately.
- ✓ Thoroughly inspect the contents for any visible damage or loose parts.

### ***IMPORTANT***

***If this procedure is not followed, the shipping company may reject the claim and the consignee may suffer the loss. Do not return the shipment to the factory.***

### Check for the following contents

Ceiling fan-coil unit with:

- Ceiling mounted fan-coil unit
- Mounting flange
- Supply/Return Grille assembly
- Wine Guardian Remote Interface Controller
- 50' of RJ9 control cable
- Documentation Bag with auxiliary data plate

Condensing Unit

- Wine Guardian Condensing Unit



## General Description

The Wine Guardian cooling unit is a professional grade, American-manufactured, split two-piece climate control unit, designed specifically for the storage of wine at cellar temperatures. It is designed for easy installation and operation. Wine Guardian uses digital electronic controls and R-134a refrigerant. The entire Wine Guardian ceiling mount fan coil section and the condensing unit is tested at the factory. All components are of a high quality standard commercial grade.

The entire system is approved by ETL according to UL 1995 and CSA safety standards. All wiring complies with NEC. Each Wine Guardian ceiling mount fan coil section is furnished with a junction box for primary power connection.

All Wine Guardian 50Hz units carry the CE mark. Each unit is furnished with a junction box for primary power connection.

## The Wine Guardian Ceiling System Contains

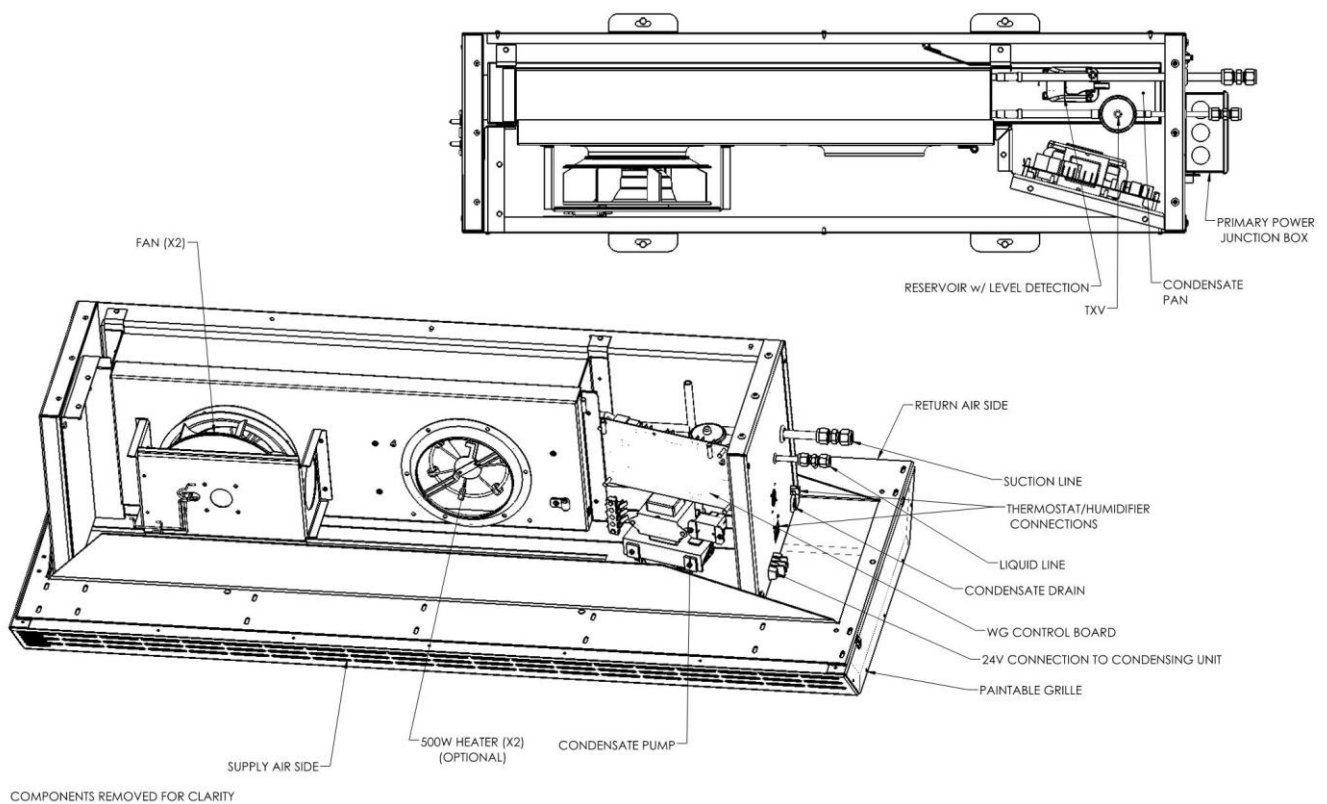

### 1. A Wine Guardian Ceiling fan-coil Unit with:

- ✓ A thermal expansion valve (TXV) to control the flow of refrigerant into the evaporator coil
- ✓ Recirc fans
- ✓ Condensate pump and float switches

- ✓ Removable, cleanable condensate pan
- ✓ Utility connections, junction box, humidifier, 24 volt control, com ports refrigerant pipe drain, etc.
- ✓ A removable control board for ease of service
- ✓ Supply-air section
- ✓ Return-air section
- ✓ Mounting flange
- ✓ Paintable Grille

**2. A Condensing Unit with:**

- ✓ A filter dryer to keep the refrigerant clean and free of contaminants
- ✓ A sight glass to observe the level of refrigerant
- ✓ A manual reset high pressure switch on the discharge to protect the compressor from high pressures.
- ✓ Auto reset low pressure switch
- ✓ 24-volt contactor for control of fan coil unit
- ✓ Outdoor enclosure
- ✓ Crankcase heater
- ✓ Low ambient refrigeration controls (see page 11 for Xtreme Low Ambient option)

## **Wine Guardian Ceiling Fan Coil Unit**

The Wine Guardian ceiling mounted fan coil unit meets its rated capacities for total BTU/H and CFM (watts and M<sup>3</sup>/h for 50Hz) at design cellar conditions and external static pressures. The ceiling mounted fan coil is capable of rated CFM (M<sup>3</sup>/h for 50Hz) against the static pressure imposed by the diffuser. The fans are a motorized impeller type, statically and dynamically balanced, and uses permanently lubricated direct drive motors requiring no maintenance.

The Wine Guardian ceiling mounted fan coil operates as air enters the device through the return air portion of the ceiling grille and is cooled by the refrigerant as it passes through the cooling coil. The cooling process causes any excess humidity in the air to condense and be captured in the drain pan which is eventually pumped out of the unit. Air then enters the fan where it is pressurized and discharged out of the unit through the supply air side of the ceiling grille. Optional heating coils are located between the cooling coil and the fan. These coils heat the air to prevent low temperatures in the wine cellar.

All exterior and interior framing of the Wine Guardian is heavy gauge aluminum to prevent rust and corrosion and all coils are aluminum tubes, aluminum fins to protect against premature corrosion. The chassis is insulated with 3/4" armaflex for thermal protection. The unit uses an external drain to remove excess moisture and not reintroduce it into the cellar or ambient space. A removable, cleanable one-piece condensate drain pan with low profile pump pickup is located below the cooling coil and is easily accessible for routine maintenance.

A heavy gauge galvanized steel mounting flange is supplied with each system. The mounting flange is designed to attach directly to the ceiling joists at either a 12-inch (31 cm) on-center or a 16-inch (41 cm) on-center configuration and acts to support the fan-coil chassis and ceiling grille. The mounting flange incorporates a hook mechanism to assist in chassis installation by creating a third arm to support the weight of the chassis as it is swung into place and fastened in place.

All utility connections including refrigerant piping, primary electrical power, 24-volt control to the remote condensing unit, control cable connections to the remote interface controller, condensate drain connection and optional remote free-standing humidifier, if purchased with system.

The ceiling diffuser is a lightweight aluminum piece that incorporates a supply and return air section divided internally to prevent short cycling. Air enters and exits the diffuser through perforated openings at its sides and draws air over sound foam insulation to reduce noise. The diffuser has an anodized finish which can be left as is...or is an ideal surface to paint to match a finished ceiling.

## **Electrical Controls**

The main electrical control board and components are located on a separate divider panel at the return air section of the unit and is accessible by removal of the ceiling diffuser and condensate drain pan. The condensate pump is also mounted to the divider panel. All wiring is in accordance with the NEC. Wires are numbered and color coded to match the wiring diagrams.

Each unit is provided with a pre-wired and tested remote interface controller for remote mounting within the wine cellar. The remote interface controller has multiple control functions for cooling, heating and operation. It has a fully automatic mode to switch between heating and cooling.

Electric power is supplied to the unit by a single factory-furnished junction box at the utility connection side of the unit. All external controls are digital and proprietary to Wine Guardian products. Only approved communication cable and Wine Guardian controllers are suitable for proper system operation.

## **Condensing Unit**

Compressors are self-lubricating, permanently sealed, hermetic reciprocating-type compressors, with internal overload protection and capacitor start. The condensing unit includes a two-year warranty. Compressors are mounted on rubber-in-shear isolators to reduce noise and vibration. Additional features include a liquid line filter drier, Sporlan Head Master Controls, a liquid line receiver and refrigerant sight glass. Each unit is housed in a painted aluminum enclosure suitable for outdoor installation. The outdoor enclosure has adequate area for ventilation and refrigerant piping penetrations.

All units come factory-configured with low-ambient protection for exposure to cold weather down to 20 Deg F. This feature controls the system pressures to prevent evaporator coil freezing (based on head pressure) and heats the compressor coil reservoir.

### **IMPORTANT**

*The air exhaust from the condensing unit is hot and will be 25 to 35 degrees F or 15°C to 20°C above the entering temperature. The condensing units are rated for a maximum temperature of 115 degrees F(46°C). The condensing units should be installed in a well-ventilated area to ensure proper air flow across the condenser coil and to limit short cycling.*

## **Accessories and Optional Equipment**

### **Extended Compressor Warranty**

The Wine Guardian uses only the best commercially available compressors on the market. However, since the compressor is the single most expensive component in the unit, it is recommended that you purchase the extended warranty option.

### **Remote sensors**

Optional remote sensors, up to three (3), can be used with each Wine Guardian unit to better control the wine cellar space. The remote sensors can either be wired directly to the Wine Guardian unit or they can be installed wirelessly. Each remote sensor is a combination temperature/humidity device and is read only, they do not display.

### **Heating Coils**

An optional heating coil is built in and requires no additional power source. The electric heating option is factory installed and includes primary and secondary over-temperature protection devices per UL and NEC.

### **Humidifier**

Another popular option for the Wine Guardian is a humidifier. The humidifier is available for split system installation and can be retrofitted onto any existing Wine Guardian unit. Each humidifier is furnished with a power cable connection to plug into the end of the Wine Guardian ceiling fan coil unit. It is then controlled by the same remote interface controller that is used for the operation of the Wine Guardian unit. The Free Standing humidifier must mount within the wine room as a secondary device. It requires a water supply and drain for operation.



**CAREFULLY FOLLOW THE INSTALLATION INSTRUCTIONS INCLUDED WITH THE HUMIDIFIER. REFER TO THE INSTRUCTIONS CONTAINED IN THE BOX FOR THE HUMIDISTAT.**

***Xtreme Low Ambient (see illustrations on following page)***

The Xtreme Low Ambient options consists of factory installed refrigeration controls mounted within the condensing unit for continuous operation of the Wine Cellar cooling unit below a temperature of 20 Deg F (-7 Deg C). Included in the refrigeration controls are;

- Check valve – installed in the liquid line between the head pressure control valve and receiver
- Fan cycling switch
- Heater – for the receiver with thermostat control
- Adjustable low-pressure cutout timer

# Xtreme Low Ambient Illustrations

Pressure cutout timer  
33C0185-00

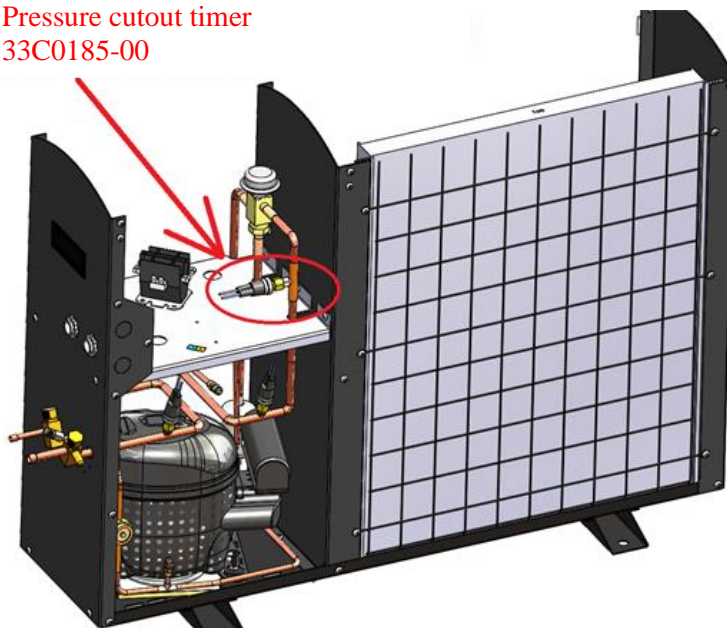

Fig. 1

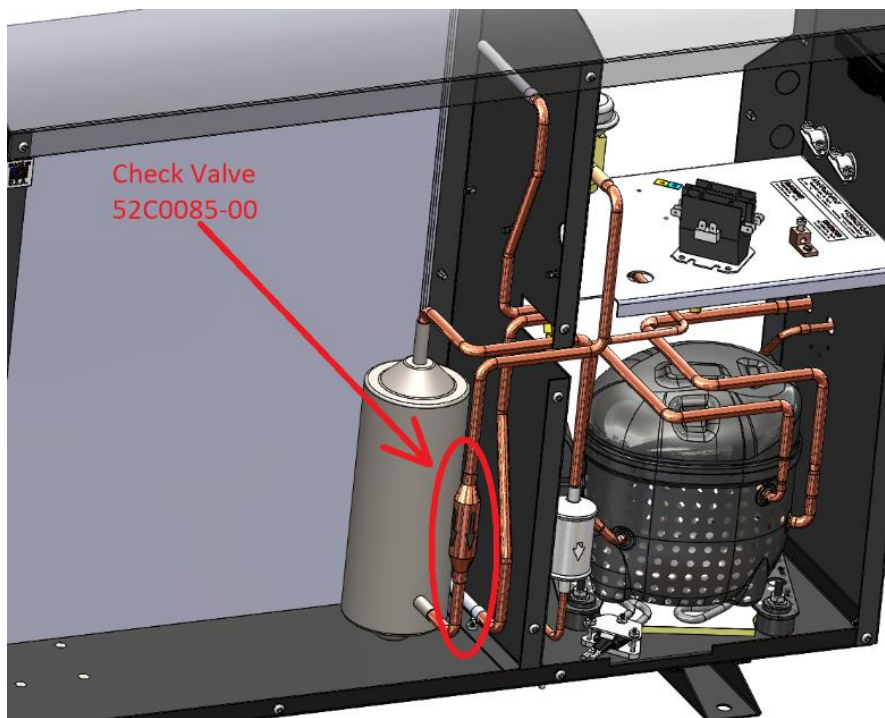
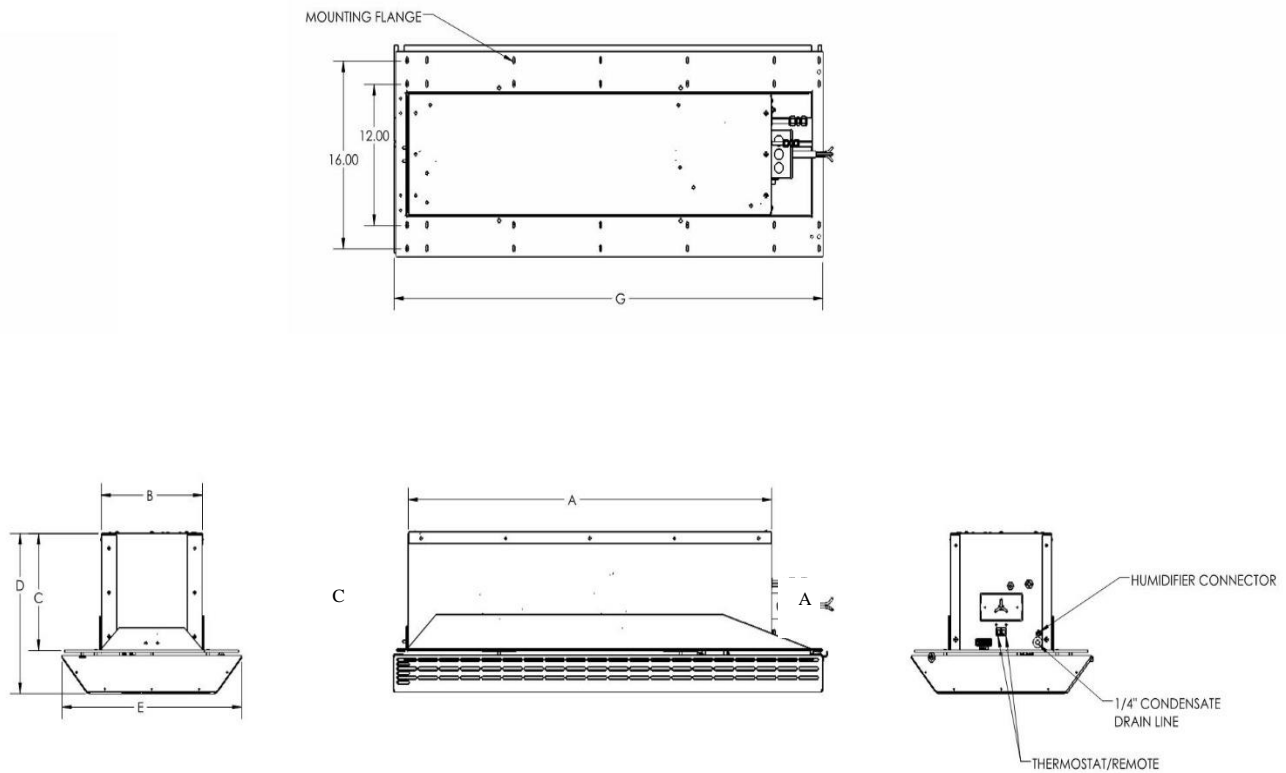

Fig. 2

## Overview of the Wine Guardian Ceiling Fan Coil System

Fig. 1



### **Wine Guardian dimensions for Ceiling Systems CS025, CS050, WGC60**

See diagram on next page for the condensing unit

Model Number	CS025 (60Hz)	CS050/WGC60 (60Hz)/(50Hz)
	Inches	Inches/cm
<b>A – Length</b>	36.6	36.6/92.96
<b>B – Width</b>	10.18	10.18/25.86
<b>C – Height</b>	9.97	9.97/25.32
<b>D – Overall height with grille</b>	13.25	13.25/33.66
<b>E – Grille width</b>	18.25	18.25/46.36
<b>F - Grille height</b>	3.25	3.25/8.26
<b>G – Grille/mounting plate length</b>	43.25	43.25/109.86
<b>Condensate drain line (ID)</b>	0.25	0.25/0.63
<b>Suction Line (OD)</b>	0.37	0.37/.93
<b>Liquid Line (OD)</b>	0.25	0.25/0.63
<b>CH – Condenser Height</b>	26.07	26.07/66.22
<b>CL – Condenser Length</b>	12.27	12.27/31.17
<b>CW – Condenser Width</b>	34.0	34.0/86.36

**Condensing unit dimensions**

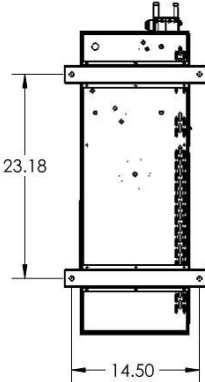
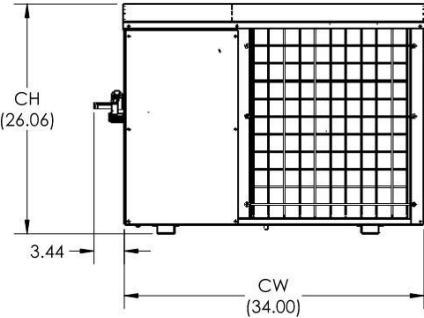
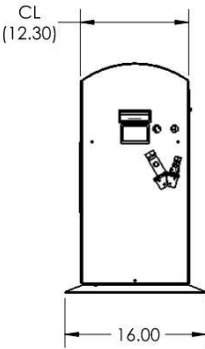



# Refrigeration Illustration of the system

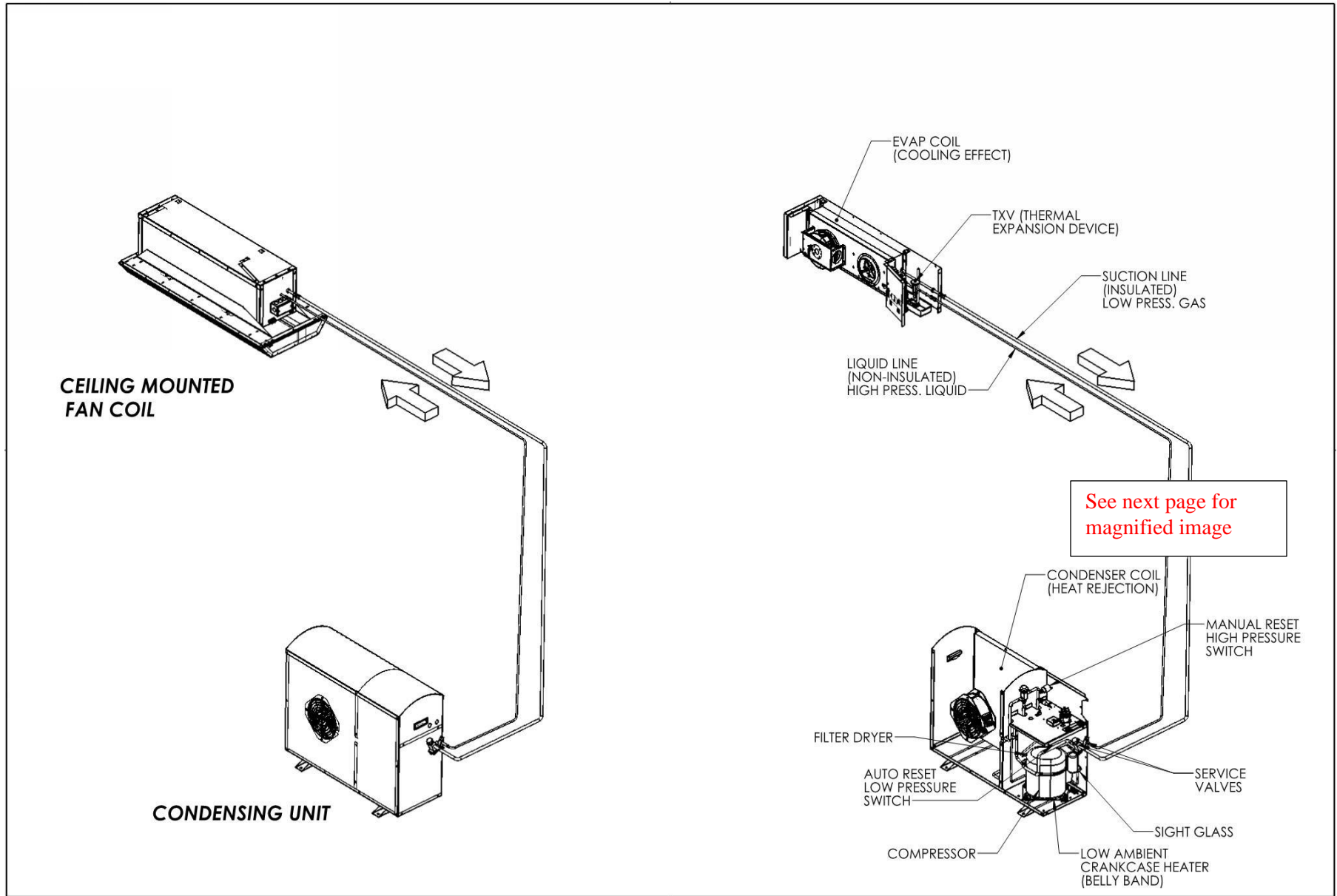

**Magnified Image of the Condensing Unit**

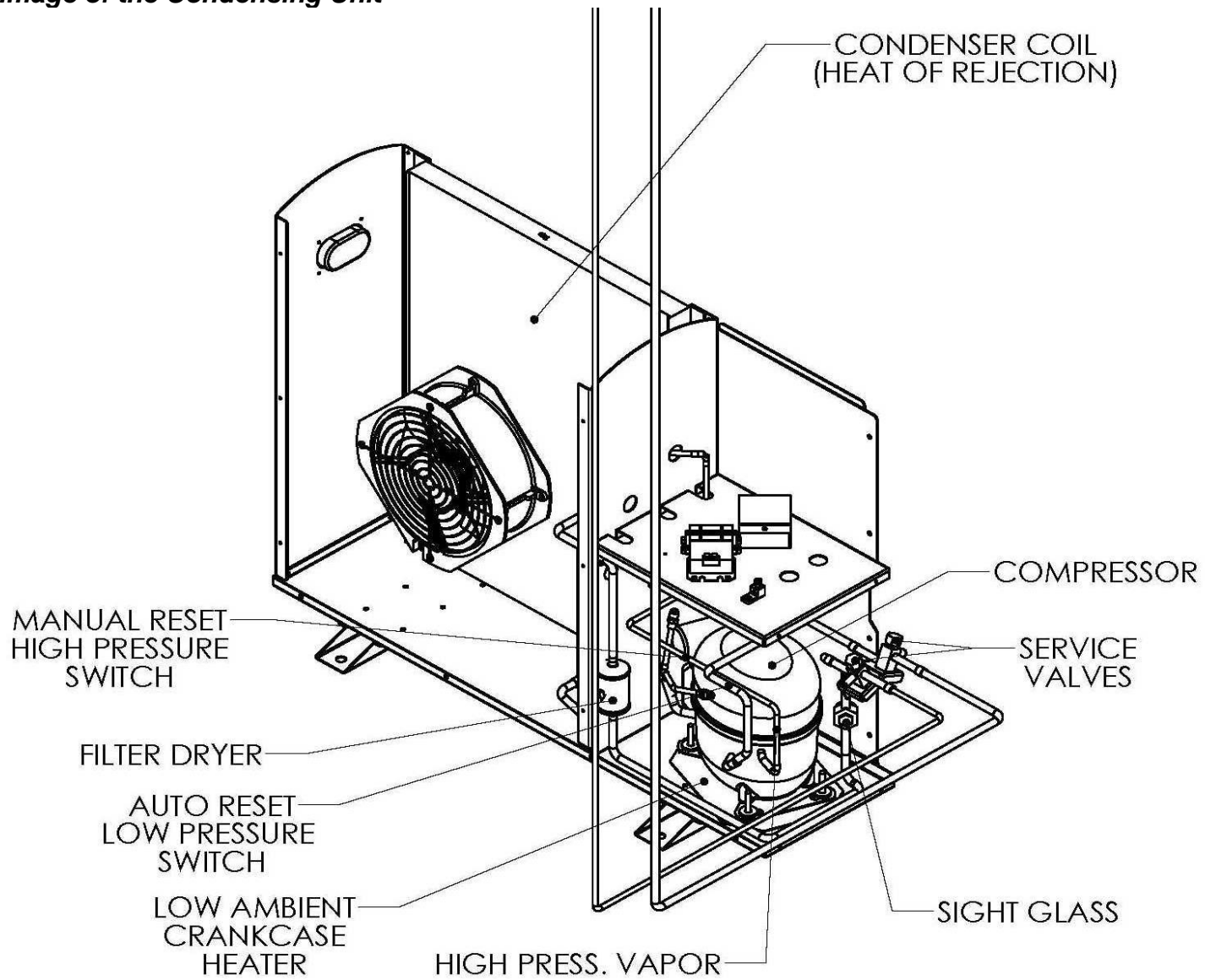

# Wiring Diagram for CS025 & CS050

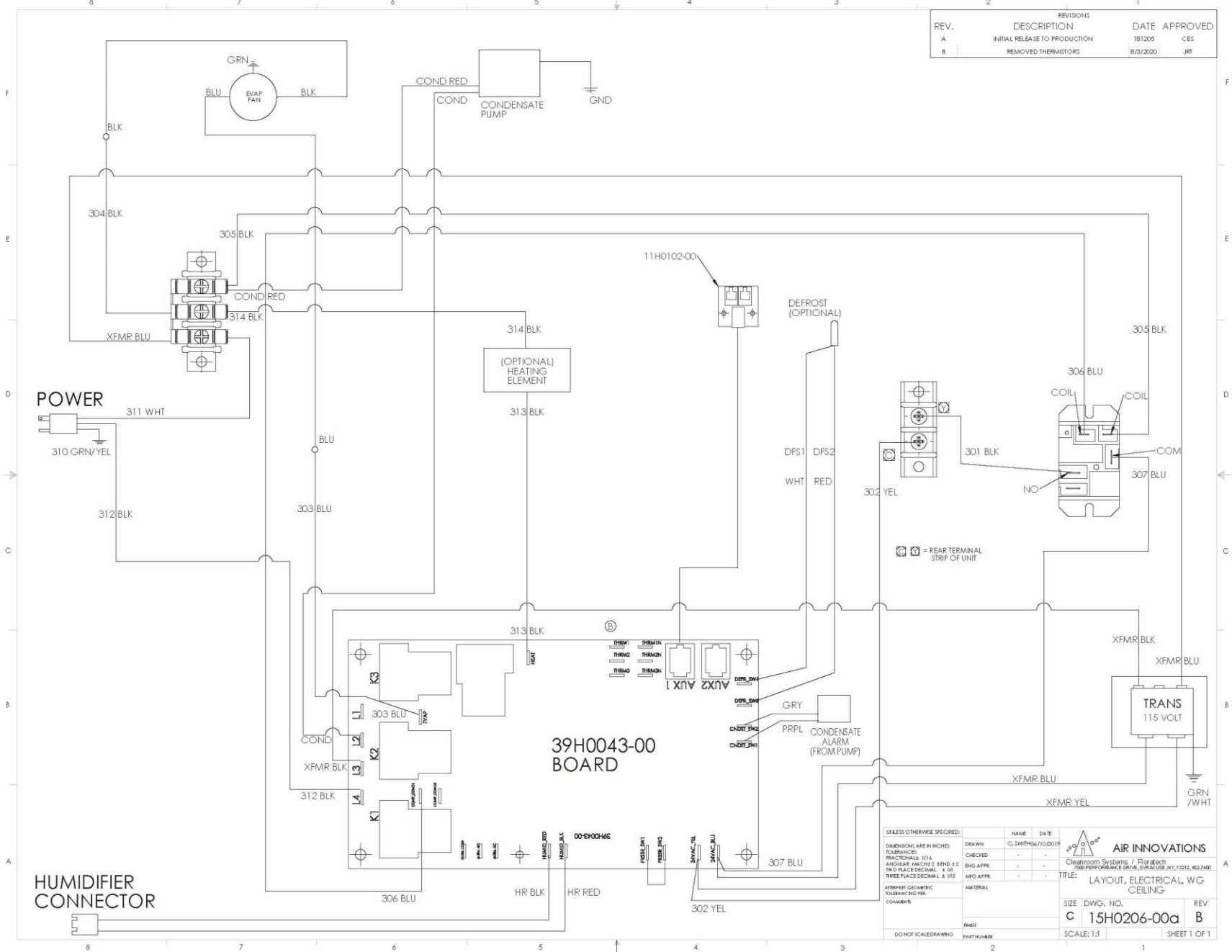

# Wiring Diagram for WGC60

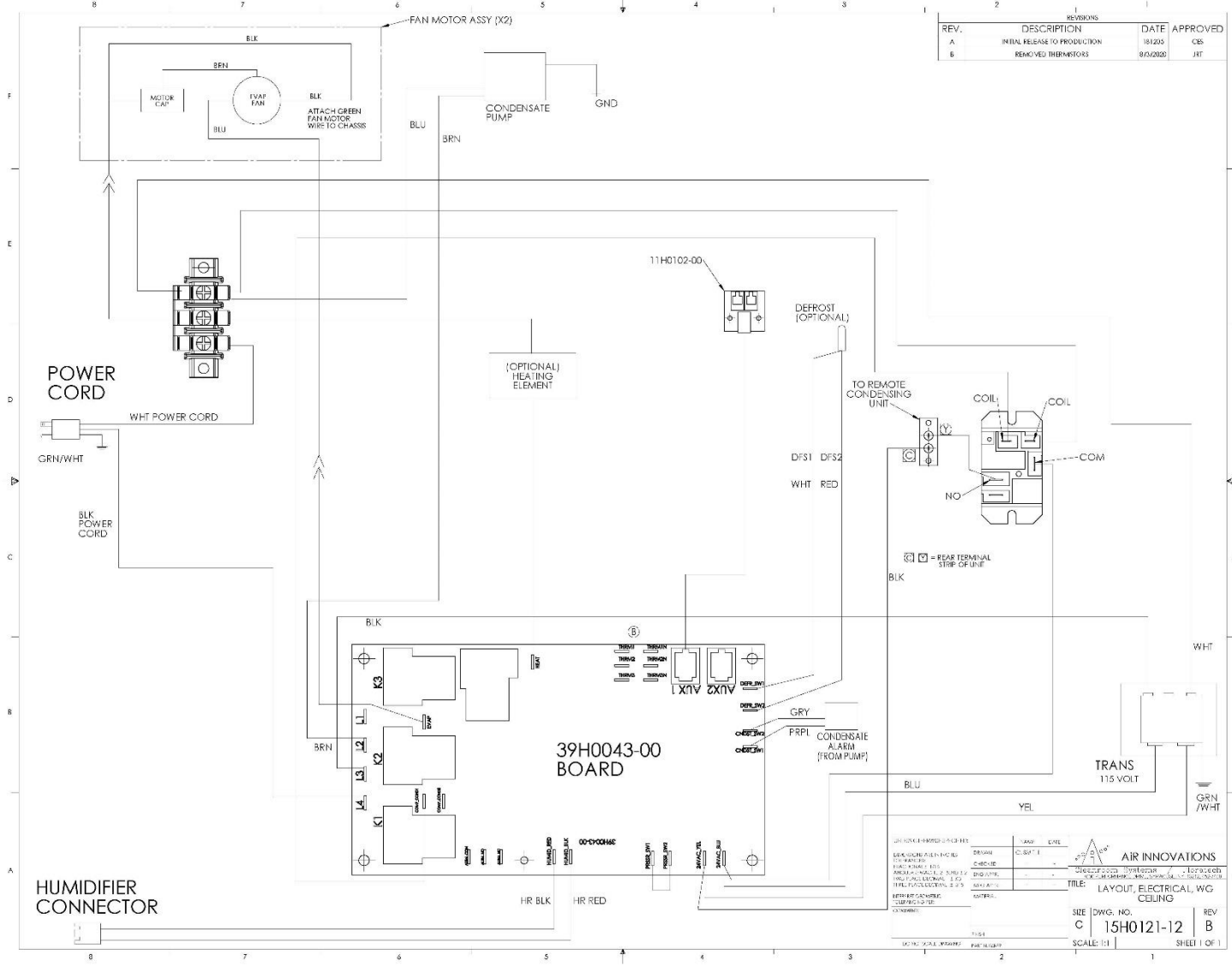

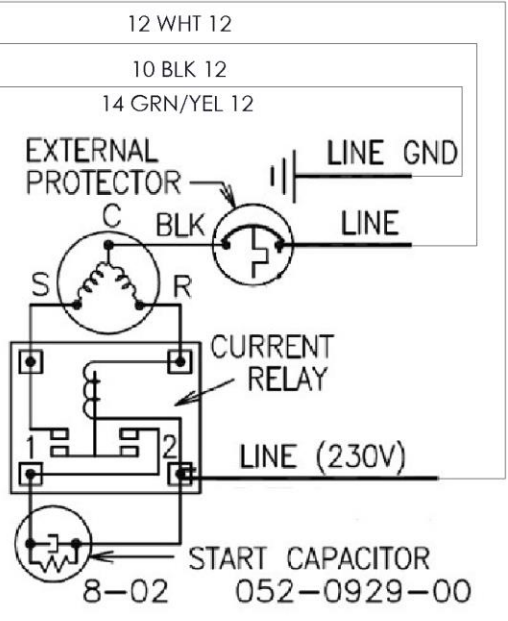
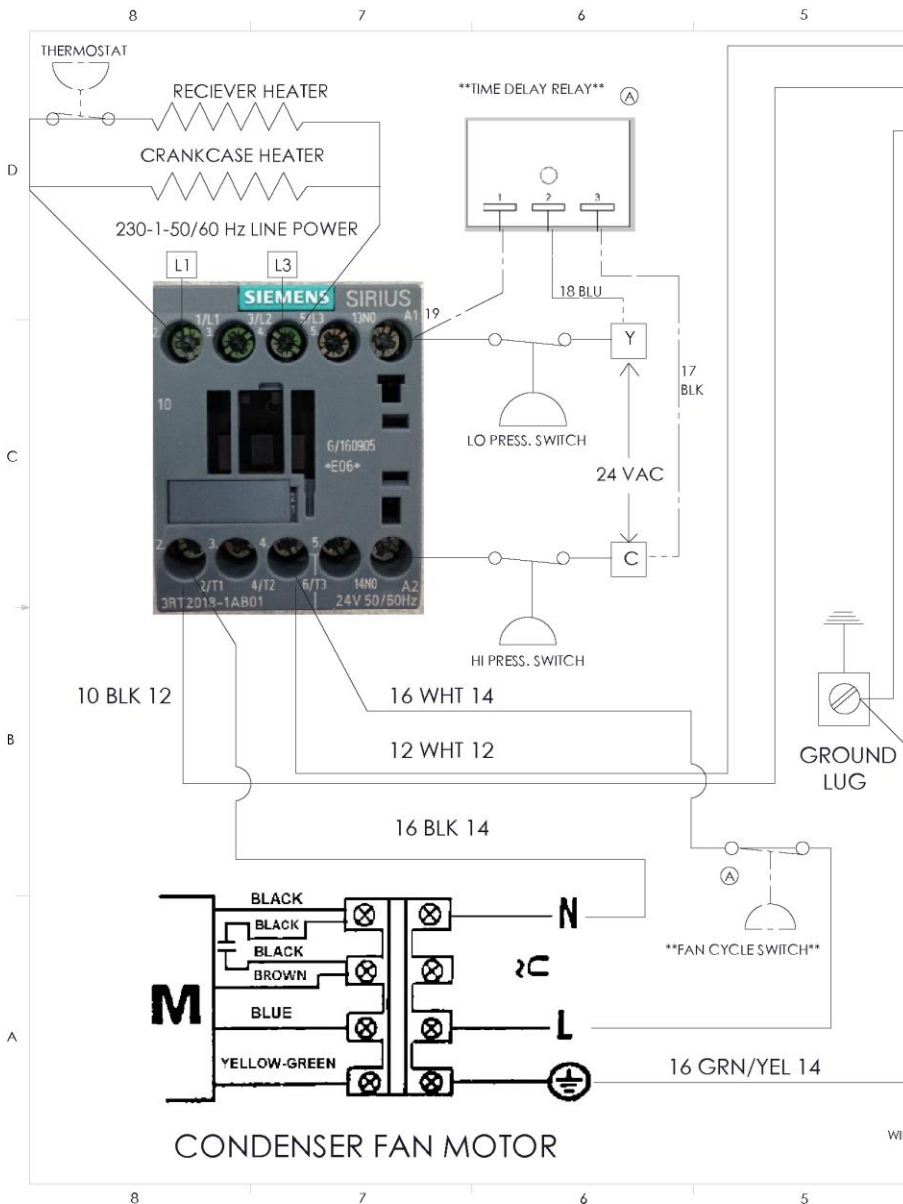

NOTE: DS025 COMPRESSOR (COPELAND)

\*\* OPTIONAL COMPONENTS, (A)  
EXTREME LOW AMBIENT KIT

FOR A COMPLETE SUMMARY OF INSTALLATION INSTRUCTIONS, VISIT - ['wineguardian.com/manuals'](http://wineguardian.com/manuals)

REVISIONS			
REV.	DESCRIPTION	DATE	APPROVED
A	ADDED OPTIONAL XLA COMPONENTS	180124	CES
B	REVISED PER ECNH-0759; ADDED T-STAT SWITCH	181106	CES

UNLESS OTHERWISE SPECIFIED:	NAME	DATE
DIMENSIONS ARE IN INCHES	DRAWN	8/25/17
TOLERANCES:	AFC	
FRACTIONAL: ± 1/16	CHECKED	
ANGULAR: MACH ± 2 BEND ± 2	ENG APPR.	
TWO PLACE DECIMAL ± .03	MFG APPR.	
THREE PLACE DECIMAL ± .015		
INTERPRET GEOMETRIC TOLERANCING PER:	MATERIAL	
COMMENTS:	FINISH	
DO NOT SCALE DRAWING		

**AIR INNOVATIONS**  
Cleanroom Systems / Floratech  
7000 PERFORMANCE DRIVE, SYRACUSE, NY, 13212, 485-7400

TITLE: ELECTRICAL LAYOUT, SPLIT SYSTEM DS025 (60 Hz) & WG40 (50 Hz) CONDENSING UNIT

SIZE: B DWG. NO.: 15H0196-00 REV: B

SHEET 1 OF 1



# Wiring Diagram for DS050 and WGS75 Condensing Unit

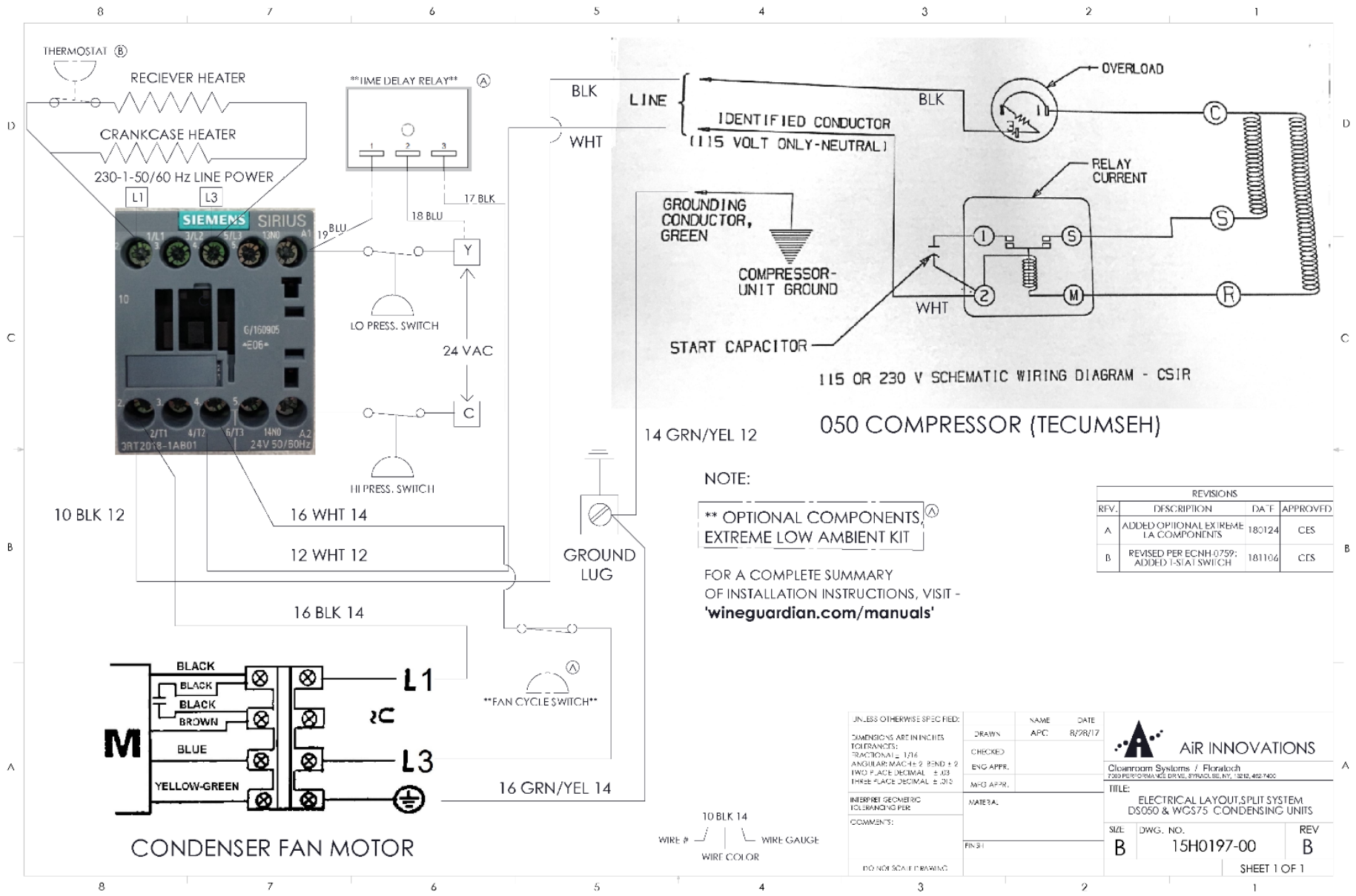

REVISIONS			
REV.	DESCRIPTION	DATE	APPROVED
A	ADDED OPTIONAL EXTREME LA COMPONENTS	180124	CES
B	REVISED PER ECNH-0759; ADDED T-STAT SWITCH	181106	CES

UNLESS OTHERWISE SPECIFIED: DIMENSIONS ARE IN INCHES TOLERANCES: FRACTIONAL ± 1/32 ANGULAR: MACH ± 9 BEND ± 9 TWO PLACE DECIMAL ± .03 THREE PLACE DECIMAL ± .010	DRAWN: APC CHECKED: ENG APPR: MFG APPR:	NAME: APC DATE: 8/28/17
INTERPRET GEOMETRIC TOLERANCES PER:	MATERIAL:	FINISH:
COMMENTS:	DO NOT SCALE DRAWING	

**AIR INNOVATIONS**

Cleanroom Systems / FlorioTech  
7300 PERFORMANCE DRIVE, SYRACUSE, NY, 13212-4627-000

**TITLE:** ELECTRICAL LAYOUT, SPLIT SYSTEM DS050 & WGS75 CONDENSING UNITS

SIZE: <b>B</b>	DWG. NO.: <b>15H0197-00</b>	REV: <b>B</b>
----------------	-----------------------------	---------------

SHEET 1 OF 1

## Ceiling System Specifications - 60Hz/50Hz Models CS025, CS050, & WGC60

# SPECIFICATIONS



### Ceiling Mount Split System

Model Number	CS025	CS050	WGC60
<b>Performance</b>			
Air flow setting at fan-coil	140CFM (factory)	190CFM (factory)	323M <sup>3</sup> /hr (factory)
Net Cooling * Total Sensible	Total/Sensible	Total/Sensible	Total/Sensible
@30°F (minus 1°C) condenser inlet air	2970/2400 BTUH	4430/3500 BTUH	1085/870 Watts
@40°F (4°C) condenser inlet air	2900/2370 BTUH	4420/3500 BTUH	1080/865 Watts
@60°F (15°C) condenser inlet air	2900/2360 BTUH	4400/3500 BTUH	1056/825 Watts
@70°F (21°C) condenser inlet air	2900/2370 BTUH	4300/3400 BTUH	1050/820 Watts
@80°F (27°C) condenser inlet air	2755/2285 BTUH	4050/3280 BTUH	990/780 Watts
@100°F (32°C) condenser inlet air	2400/2100 BTUH	3500/2930 BTUH	855/675 Watts
@115°F (46°C) condenser inlet air	2200/2000 BTUH	3080/2850 BTUH	752/600 Watts
<b>Controls</b>			
Type	Room-mounted, non-programmable combination thermostat humidistat		
Temperature Accuracy/RH% Accuracy	+/- 1 Deg F / +/- 5% RH		
<b>Fan-coil Section</b>			
Fan Motor Size (Amps/Watts) rating	.75 / 85 (x2 fans)	.75 / 85 (x2 fans)	.75 / 85 (x2 fans)
Rated Air Flow (free blow)	140 CFM	190 CFM	323M <sup>3</sup> /hr
<b>Heat (Option)</b>			
Type	Electric		
Capacity	1000 Watts		
<b>Humidifier (Option)</b>			
Type	Free Standing with removeable drip pad and integral fan		
Capacity - water temp of 60°F (15°C)	0.42 lbs/hr		.19 kg/hr
Capacity - water temp of 90°F (32°C)	0.97 lbs/hr		.44 kg/hr
Capacity - water temp of 120°F (49°C)	1.11 lbs/hr		0.5 kg/hr
<b>Electrical Requirements - Evaporator Section</b>			
Power	115 Volts/1 phase/60Hz	115 Volts/1 phase/60Hz	220/240 Volts/1 Phase/50Hz
Current Draw - Cooling mode	1.5 Amps	1.5 Amps	.6 Amps
Current Draw - Heating mode	10.2 Amps	10.2 Amps	4.8 Amps
Minimum Circuit Size (w/heat option)	12.4 Amps	12.4 Amps	5.9 Amps
Optional Free Standing Humidifier	0.3 Amps	0.3 Amps	0.3 Amps
<b>Cabinet - Evaporator Section</b>			
Fan coil construction	Aluminum		
Finish	Paintable anodized aluminum grille, chassis is unpainted raw aluminum		
Weight	51 lbs	51 lbs	23 kg
Length	36 <sup>1/2</sup> inches	36 <sup>1/2</sup> inches	92.7cm
Width - Chassis/Diffuser	10 <sup>1/8</sup> / 18 <sup>1/8</sup> inches	10 <sup>1/8</sup> / 18 <sup>1/8</sup> inches	25.7cm / 46cm
Height - Chassis/ With diffuser	9 <sup>1/2</sup> / 12 <sup>3/4</sup> inches	9 <sup>1/2</sup> / 12 <sup>3/4</sup> inches	24.1cm / 32.4cm
Condensate Drain	1/2 inch	1/2 inch	1.3cm
<b>Condensing Unit</b>			
	<b>DS025 Cond</b>	<b>DS050 Cond</b>	<b>WGS75 Cond</b>
Nominal Compressor	3.1 Amps	4.8 Amps	3.9 Amps
Fan Motor Size	75 Watts	75 Watts	68 Watts
Rated Air Flow (free blow)	275 CFM	375 CFM	850 M <sup>3</sup> /h
Weight	75 lbs	76 lbs	35 kg
<b>Enclosure - Condensing Unit</b>			
Construction	Aluminum		
Finish	Powder-coated		
Length	34 inches	34 inches	86.4 cm
Width	12 inches	12 inches	30.5 cm
Height	26 inches	26 inches	66 cm
<b>Electrical Requirements - Condensing Unit</b>			
Power	208-230 Volts/1 Phase/60Hz	208-230 Volts/1 Phase/60Hz	220-240 Volts/1 Phase/50Hz
MCA	4.2 Amps	6.4 Amps	5.2 Amps
MOP	8.0 Amps	10.0 Amps	9.0 Amps
<b>Agency Approval(s)</b>	ETLc		CE

1. Net cooling capacity at entering temperature and humidity conditions of 57 Deg F (14 Deg C) and 55% RH at rated airflow. Reduce capacity by 3% for each 10% reduction in evaporator airflow.

2. Wine Guardian reserves the right to make changes to this document without prior notice at its sole discretion.

3. All ratings at sea level.

4. All btuh capacity and airflow (CFM) values shown are at tested 230v (220v for 50Hz) applied on 208/230v rated units (Condensing units and larger evaporators). If field application allows 208v applied to the units dual rated, you can generally expect 2.5%-3.0% decreases in values shown.

## Safety

### **IMPORTANT**

***The equipment described in this manual uses electricity. When using this equipment, be sure to follow the safety procedures outlined in this manual.***

## Safety Message Conventions

Safety messages contained in this manual, DANGER, WARNING, and CAUTION are bold and highlighted in red for quick identification.

### ***Danger***

A Danger message indicates an imminently hazardous situation which, if not avoided, results in death or serious injury. Messages identified by the word **DANGER** are used sparingly and only for those situations presenting the most serious hazards.

Following is a typical example of a Danger message as it could appear in the manual:

 **DANGER**  
**HIGH VOLTAGE - RISK OF SERIOUS INJURY OR DEATH**  
**High voltages are present in the cabinets.**  
**Before opening panels turn off all power.**  
**Use the Lockout/Tagout procedure.**

### ***Warning***

Following is a typical example of a Warning message as it could appear in the manual:

 **WARNING**  
**RISK OF PERSONAL INJURY OR DAMAGE TO EQUIPMENT**  
**Modification to the equipment may cause injury.**

### ***Caution***

A Caution message indicates a potentially hazardous situation which, if not avoided, could result in minor or moderate injury. It may also be used to alert against unsafe practice.

Following is a typical example of a Caution message as it could appear in the manual:

**RISK OF PERSONAL INJURY OR DAMAGE TO EQUIPMENT**  
**Improper installation may result in the equipment malfunctioning and a safety hazard.**  
**Read all of the installation instructions before installing the Wine Guardian unit.**



## Lockout/Tagout Procedure

- 1) Turn off system at Remote Interface Controller by hitting the on/off button
- 2) Turn off circuit breaker or disconnect switch to ceiling mounted unit.
- 3) Turn off circuit breaker or disconnect switch at condensing unit.

## Safety Considerations

The equipment covered by this manual is designed for safe and reliable operation when installed and operated within its designed specifications. To avoid personal injury or damage to equipment or property when installing or operating this equipment, it is essential that qualified, experienced personnel perform these functions using good judgment and safe practices. See the following cautionary statements.

**IMPORTANT**  
***Installation and maintenance of this equipment is to be performed only by qualified personnel who are familiar with local codes and regulations and are experienced with this type of equipment.***

### **Safety Hazards**

Exposure to safety hazards is limited to maintenance personnel working in and around the unit. When performing maintenance, always use the Lockout/Tagout procedure, which is described in this chapter. Observe the maintenance safety guidelines in this manual.

### **Electrical Hazards**

Working on the equipment may involve exposure to dangerously high voltage. Make sure you are aware of the level of electrical hazard when working on the system. Observe all electrical warning labels on the unit.

### **Electrical Shock Hazards**

All power must be disconnected prior to installation and servicing this equipment. More than one source of power may be present. Disconnect all power sources to avoid electrocution or shock injuries.

### **Hot Parts Hazards**

Electric resistance heating elements must be disconnected prior to servicing. Electric heaters may start automatically. Disconnect all power and control circuits prior to servicing the unit to avoid burns.

### **Moving Parts Hazards**

**The Motor and Blower** must be disconnected prior to opening access panels. The motor can start automatically. Disconnect all power and control circuits prior to servicing to avoid serious injuries or possible dismemberment.

**The fans** are free-wheeling after the power is disconnected. Allow the fans to stop completely before servicing the unit to avoid cuts or dismemberment.

**Rotating Fan Blades** are present in the Wine Guardian unit. Sticking a hand into an exposed fan while under power could result in serious injury. Be sure to use the Lockout/Tagout procedure when working in this area or remove the power cord.

## Equipment Safety Interlocks

There are no electrical safety lockouts installed within the unit. Primary power must be disconnected from the units prior to working on any part of the electrical system.

## Main Power Switch

An appropriately sized circuit breaker and/or disconnect switch must be installed on the primary power source of the ceiling mounted fan-coil unit. A separate disconnect switch must be wired to the condensing unit. Both switches must be turned off prior to servicing equipment.

<b>Energy Type</b>	<b>Electrical</b>
Hazard.....	Electrocution, electrical burns and shock
Magnitude.....	120 volts and 230 volts / 1phase / 60Hz (CS025 and CS050 model) 220-240 volts / 1 phase / 50Hz (WGC60 model)
Control Method.....	Circuit breaker and disconnect switch



- **Never** reach into a unit while the fan is running.
- **Never** remove the supply/return ceiling grille while the fan is running.
- **Disconnect** the power before working on the unit. The unit may have more than one power source to disconnect.
- **Avoid** risk of fire or electric shock. **Do not** expose the unit to **rain** or **moisture**.



- **Check** weights to be sure that the rigging equipment can support and move the Wine Guardian unit safely. Note any specific rigging and installation instructions located in the Installation section of this manual.
- All supports for the unit **must** be capable of safely supporting the equipment's weight and any additional live or dead loads encountered.
- All supports for the unit **must** be designed to meet applicable local codes and ordinances.
- **Do not** remove supply/return ceiling grille until fan impellers have completely stopped. Fan impellers continue to turn (free-wheel) after the power is shut off.



- **Clean** only with a dry cloth.
- **Never** pressurize equipment above specified test pressure. See Wine Guardian Specification sheet on pages 24 & 25.
- **Do not use the Wine Guardian near water.**
- **Do not** block supply and/or return openings of ceiling grille. Install in accordance with the instructions in this manual.
- **Only** use attachments/accessories specified by the manufacturer.
- **Always** operate this equipment from a 120/230 VAC, 1 phase, 60Hz power sources only (220/240 volts / 1 phase/ 50Hz models).
- **Always** ground the outlet to provide adequate protection against voltage surges and built-up static charges.
- **Refer all** servicing to qualified service personnel. Servicing is required when the unit has been damaged in any way.

## Installation



**CAUTION**  
**SHARP EDGES**  
**RISK OF SERIOUS INJURY**

**Sharp edges are present inside the Wine Guardian system.**

**Prior to installation check system for non-visible shipping damage.**

## Planning the Installation

### **IMPORTANT**

***Installation of residential and commercial split systems must be performed by qualified service technicians with proper training in the installation, start up, service, and repair of these systems. Certification to handle refrigerants is also required.***

## Addressing Items in the Planning Process

- ✓ Where to locate the fan coil unit in the ceiling? Consider the orientation of the unit and the supply and return grille locations relative to the room layout.
- ✓ How to mount the fan coil unit? Which way do the ceiling joists run and do I have enough clearance to flush mount the system or will it be exposed within the room.
- ✓ How to route the utilities to the ceiling fan-coil unit including the refrigerant line set to the condensing unit, condensate drain, control wiring, thermostat control cable and the optional humidifier control wire.
- ✓ Locate the condensing unit in a clean and well-ventilated area.
- ✓ Where to locate the remote interface controller and/or remote sensors?
- ✓ Where to run the drain line? How and where do you tie-in the line to the home or facility?
- ✓ Are all the parts on-site and available to complete the installation?

## Performing a Pre-Installation Check

- ✓ Check for the properly sized breakers for both the condensing unit and fan coil section.
- ✓ Is the cellar built with adequate insulation and vapor barriers?
- ✓ If glass is part of the wine room design is it sealed and if glass doors are used are they sealed?
- ✓ Is enough space available around the units for service and repair?

# Installing the Ceiling Fan Coil unit

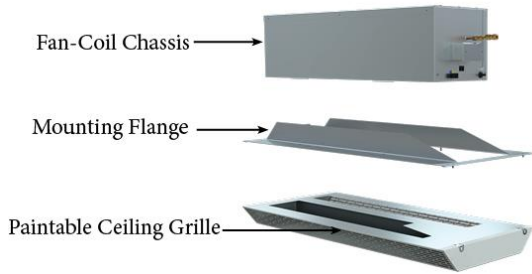

The ceiling unit consists of three main components that are required for proper installation — the fan-coil chassis, the mounting flange, and the paintable ceiling grille.

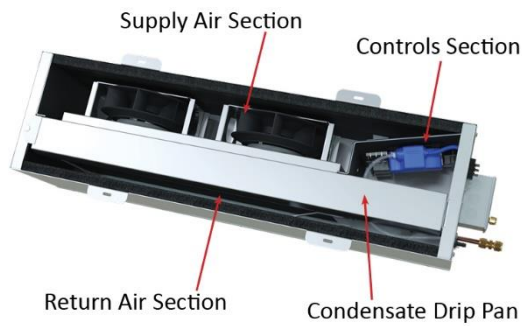

The fan coil chassis incorporates a return-air section which directs air through the evaporator coil, a supply air section with fan shroud, dual motorized impeller fans and optional heaters. The chassis also features a separate controls section along with a one-piece removable condensate drip pan with pump pick up, float switch and connection ports.

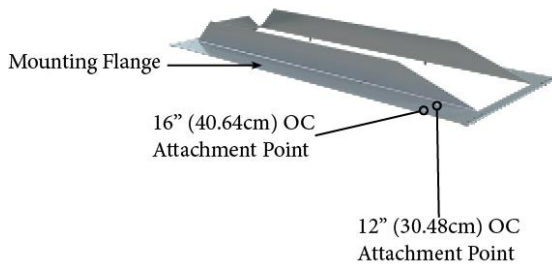

The mounting bracket is designed of heavy gauge galvanized steel and will attach to either 16" (41 cm) on-center or 12" (31 cm) on-center joist spacing.

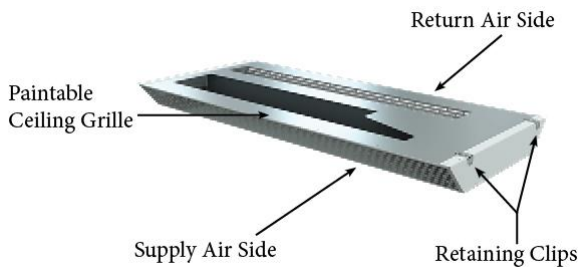

The ceiling grille is the part of the unit that will be visible in the wine room and consists of the supply-air side and the return-air side. The exposed grille is an anodized aluminum finish that is paintable.

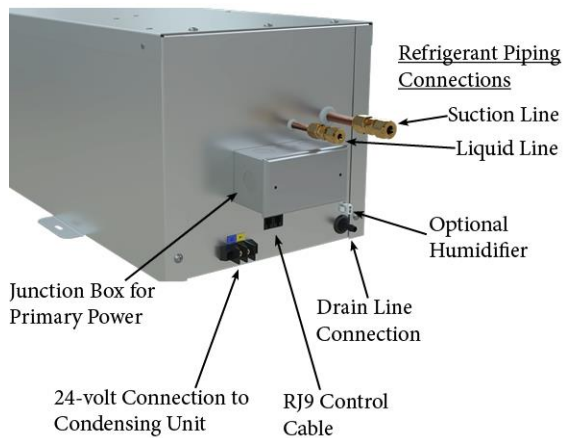

Looking at the utility connection end of the unit, the chassis has five main connection points.

- Junction box for primary power connection (120v/1ph/60hz or 220v/1ph/50hz.)
- Refrigerant piping connections, suction and liquid lines to remote condensing unit.
- 24 volt control between ceiling fan-coil and remote condensing unit.
- RJ9 control cable connection to the remote interface controller and optional remote sensors.
- Drain line connection.
- Optional humidifier connection

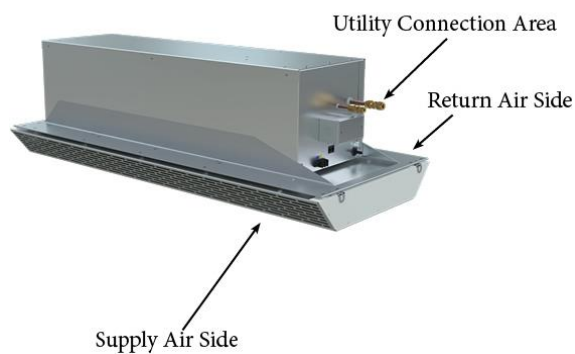

When installing the Wine Guardian ceiling system it's important to understand the orientation of the unit, where the supply and return are located in relation to the connection points and how that will affect the wine room when installed. As an example, when installing within a glass enclosure you may not want the cold air blowing directly onto the glass therefore determining the correct orientation for supply/return is extremely important. Also, utility connections are at one end of the unit ONLY so understanding where those connections are to be made is important.

### IMPORTANT

The below photo shows the mounting flange attached directly to the joists for illustration purposes ONLY. The mounting flange MUST be installed after the sheetrock or ceiling face material has been installed.

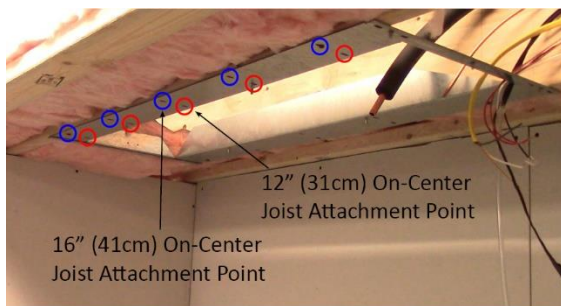

Ceiling joists are normally either 12" (31 cm) on-center or 16" (41 cm) on-center. This means that the center of individual wooden joists are either a consistent 12" (31 cm) or a consistent 16" (41 cm) apart from each other. The Wine Guardian galvanized steel mounting flange will fit comfortably between 12" (31 cm) or 16" (41 cm) on-center ceiling joists and allow you to attach to either configuration.



Before installing any wine cellar cooling system, it is important to make sure the wine room is properly constructed. Follow Wine Guardian’s “How to Build a Wine Cellar” video for assistance.

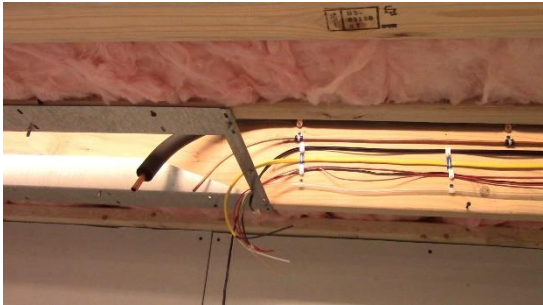

The first step in the installation process is to route all of the utilities to the area of the ceiling in which the Wine Guardian Ceiling System will be mounted. Required connections: refrigerant piping, primary power, drain line, RJ9 Control cable, 24-volt control to condensing unit and optional humidifier connection.



Once the ceiling has been insulated and the sheet rock or ceiling material has been installed, clearly mark and cut-out the opening in the ceiling where the unit will be installed. The cut-out opening should be no larger than the following:

16” (41 cm) joist spacing = 41” (104 cm) long X 14.5” (37 cm) wide

12” (31 cm) joist spacing = 41” (104 cm) long X 10.5” (27 cm)



Make sure to take joist location into account before cutting the hole for the unit. For old construction make every precaution to ensure the mounting area is free and clear of utilities prior to cutting the ceiling.



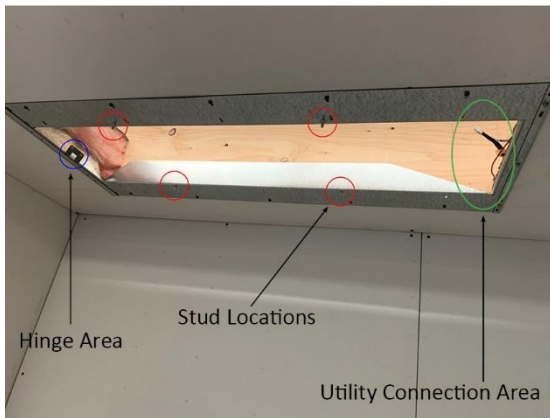

Once the hole for the unit is cut out, place the mounting flange up onto the ceiling with the studs pointing down and the hinge area placed on the opposite side of the utility connection area. Attach the mounting bracket to the ceiling using 2 ½” flat head screws making sure to penetrate the joists for secure attachment.

At this point you can add additional insulation to the sides and top of the mounting area as required to ensure the envelope is completely insulated and protected.

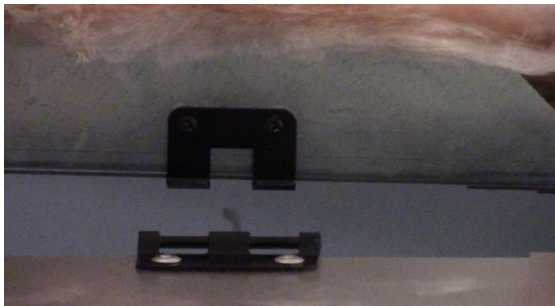

Now that we have the mounting bracket installed, we can install the fan coil. The first step to installing the fan coil is to line up the latch-end with the hook-end on the mounting bracket. Lift the fan coil up onto the mounting bracket so that the fan coil latch-end rests on its mating hook-end.

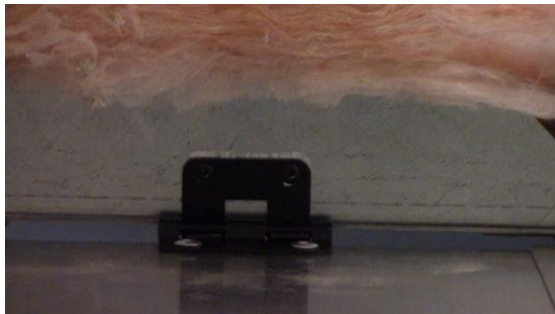

This latch system works as a third hand and allows you to swing the fan-coil up into position. Swing the fan-coil chassis up into place so that the slotted areas at either long end of the unit slide over the threaded connections on the mounting flange



Fasten to the mounting bracket at the four threaded connection points using a washer, lock washer and nut and tighten.



Once the fan coil is in place connect the utilities to the unit. Start with the refrigerant piping. The Wine Guardian unit ships complete with Swagelok piping connections on the suction line and liquid line. Follow the manufacturers connection instructions starting on page 35 for proper attachment.

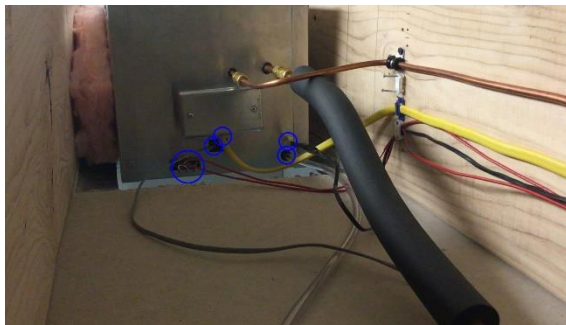

Continue with the primary power, 24v control to condensing unit, remote interface controller connection and the drain. (see page 36, 37 and 38 for additional instructions). If you ordered the Ceiling System with an optional Free-standing humidifier, the humidifier will also need to be connected to the unit during this step.



After all utilities are connected to the unit, fill in any voids or holes with insulation. Closed-cell spray foam is a common insulation method, and it provides excellent vapor barrier and insulative properties.

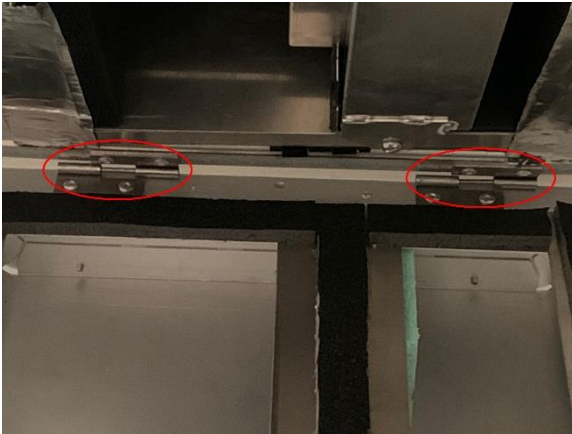

Attach the ceiling grille to the mounting flange. The ceiling grille has a hinge at one end and two mounting clips on the opposite end. To begin, line up the hinge-end of the ceiling grille with the hinges on the mounting bracket. Next, with the flat, gasketed side of the grille facing up towards the ceiling, lift the grille up towards the mounting flange and slide the hinges on the grille into the hinges on the mounting flange. Once the hinge is attached and secure, lift the opposite end of the grille up to the mounting flange so that the grille slides over the pins adjacent to the mounting clips. Once the ceiling grille is in place close each clip by moving it in toward the end of the grille.



**Continue to the installation of the condensing unit as shown on page 38 below prior to start-up of the system**



**CAUTION**



**RISK OF PERSONAL INJURY OR DAMAGE TO EQUIPMENT**

**Check supporting structure for load bearing capacity to support the Wine Guardian. All supports must be designed to meet applicable local codes and ordinances. If in doubt, consult a qualified architect, engineer or contractor.**

## Installing the Condensate Drain Connection

The Wine Guardian unit provides dehumidification for the inside of the wine cellar. It cools the air down to the dew point corresponding to the temperature setpoint of the remote interface controller. If the vapor barrier of the wine cellar is poorly constructed or excess moisture is in the ambient area, the unit may remove excessive amounts of moisture from the wine cellar. The moisture appears in the condensate drain of the unit.

### Installing the Drain Line

- ✓ The drain line must extend from the unit to an external drain or disposal site. Do not use drain tubing any smaller than one-quarter inch inside dimension.

The Wine Guardian unit has a built-in condensate pump which has the following specifications. The pump has the ability to pump 1.2 Gallons per day (4.5 Liters per day) of water to a maximum height of 20' from the ceiling unit. The pump pick-up is located within the condensate drain pan and has a float switch which when activated turns the pump on to remove water from the drain pan. Should water rise above the float level an auxiliary switch turns off the cooling unit and the pump will continue to operate until the water level drops below the float switch. The cooling unit will also remain off until excess water is below the auxiliary safety switch.

### Priming the Condensate Pump

The internal pump primes itself automatically once the unit has run for a period of time and after the unit cycles off.

## Refrigerant piping Swagelok connection Installation Instructions

Swagelok tube fittings 1 in./25 mm and smaller can be installed quickly, easily, and reliably with simple hand tools. Over 1 in./25 mm sizes require use of a hydraulic swaging unit to swage the ferrules onto the tubing.

### Safety Precautions

- Do not bleed system by loosening fitting nut or fitting plug.
- Do not assemble and tighten fittings when system is pressurized.
- Make sure that the tubing rests firmly on the shoulder of the tube fitting body before tightening the nut.
- Use the correct Swagelok gap inspection gauge to ensure sufficient pull-up upon initial installation.
- Always use proper thread sealants on tapered pipe threads.
- Do not mix materials or fitting components from various manufacturers—tubing, ferrules, nuts, and fitting bodies.
- Never turn fitting body. Instead, hold fitting body and turn nut.

- Avoid unnecessary disassembly of unused fittings.
- Use only long reducers in female Swagelok end connections.

See the instructions starting below for installation of Swagelok tube fittings, O-seal male connectors, caps and plugs, port connectors, tube adapters, position-able elbows and tees, weld fittings, depth marking tool, and pre-swaging tool.

## Swagelok Tube Fittings Up to 1 in./25 mm

These instructions apply both to traditional fittings and to fittings with the advanced back-ferrule geometry.

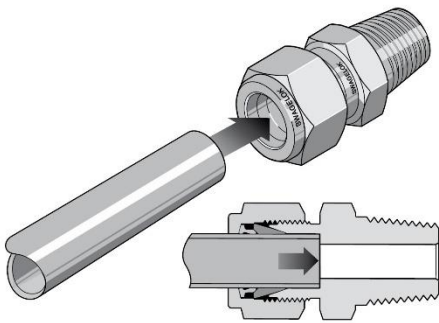

Fully insert the tube into the fitting and against the shoulder; rotate the nut finger-tight.

*High-pressure applications and high safety factor systems: Further tighten the nut until the tube will not turn by hand or move axially in the fitting.*

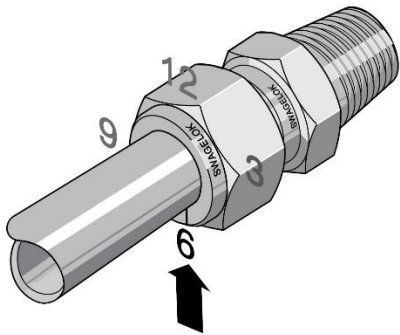

Mark the nut at the 6 o'clock position. While holding the fitting body steady, tighten the nut one and one quarter turns to the 9 o'clock position.

*For 1/16, 1/8, and 3/16 in.; 2, 3, and 4 mm tube fittings, tighten the nut three quarter-turn to the 3 o'clock position.*

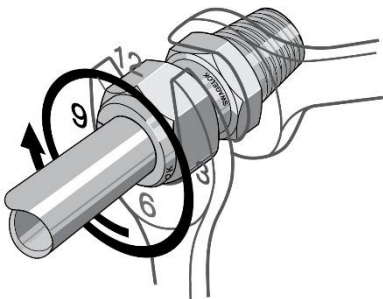

## Reassembly – All Sizes

**You may disassemble and reassemble Swagelok tube fittings many times.**

- **Always depressurize the system before disassembling a Swagelok tube fitting.**

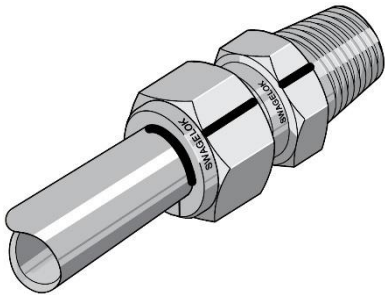

Prior to disassembly, mark the tube at the back of the nut; mark a line along the nut and fitting body flats. *Use these marks to ensure that you return the nut to the previously pulled-up position.*

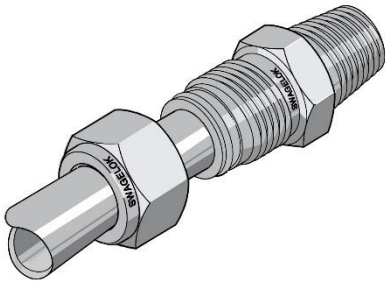

Insert the tube with pre-swaged ferrules into the fitting until the front ferrule seats against the fitting body. *Over 1 in./25 mm sizes: If needed, reapply lubricant lightly to the body threads and the rear surface of the back ferrule.*

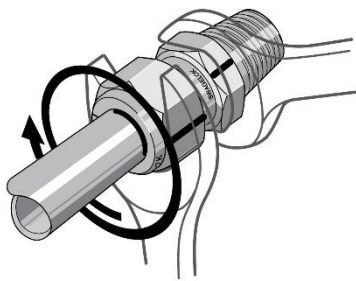

While holding the fitting body steady, rotate the nut with a wrench to the previously pulled-up position, as indicated by the marks on the tube and flats. At this point, you will feel a significant increase in resistance. Tighten the nut slightly.

- **Do not use the Swagelok gap inspection gauge with reassembled fittings.**

## Wiring the Fan Coil Unit for Power



**DANGER**  
**ELECTRICAL SHOCK HAZARD**  
**RISK OF SERIOUS INJURY OR DEATH**

**The electrical outlet and wiring installation must meet the national and local building codes.**

**DO:**

Provide dedicated circuit and wiring for the system.  
Match the wiring and breaker size to the rated load as shown on the serial plate and in this guide. See sample serial plate illustration below.

99H0368-00		Serial # <b>16F28864</b>
		Rev: <b>A</b>
Electrical	115/1/60	Electrical heat Amps (opt) 8.7
Locked Rotor Amps	48	Humidifer Amps 0.3
Compressor RLA	9.5	Crankcase Htr Amps (opt) 0.4
Condenser Fan Amps	1.0	Min. Circuit Amps (w/o opt) 13.9
Evaporator Fan Amps	1.0	<b>Refrigerant R-134A</b>
Condensate Heater	N/A	<b>System Charge 1 lbs 12 oz</b>
Total Unit Amps (w/o opt)	11.5	Test Pressure 275 psi
Air Innovations, 7000 Performance Dr. North Syracuse NY 13212 Ph: 800-825-3268 *315-452-7400 <a href="http://www.airinnovations.com">http://www.airinnovations.com</a>		

**.DO NOT:**

- ✓ DO NOT MODIFY THE ELECTRICAL WIRING WITHIN THE CEILING UNIT.
- ✓ Do not use extension cords.

**IMPORTANT**

**The electrical power supply must be 115 volt AC 1 phase, 60 cycle, for model CS025 and CS050 and 220/240 volt, 1 phase, 50 cycle for model WGC60.  
This cannot vary more than plus or minus 4% or damage may occur to the unit.**

## Installing the Condensing Unit

- Condensing units are factory assembled with an aluminum outdoor enclosure for protection from the elements.
- A minimum of 12 inches (30cm) is required around the perimeter of the condensing unit for proper airflow across the coil, and to provide an adequate discharge airflow path. Any obstructions to this airflow will result in a decrease in performance, and possibly premature failure due to a buildup of high pressure within the system.
- The condensing unit is designed to operate in ambient temperatures ranging from 0°F-115°F (minus -18°C - 46°C), as it is supplied with many standard features to assist full operation in this wide range.
- Mount the condensing unit above normal snowfall levels, so as to allow uninhibited winter operation. A buildup of snow or any obstruction to airflow will result in a decrease in performance and possible premature failure due to an increasingly high pressure within the system.

## Installation of Interconnecting Refrigerant Lines (Suction and Liquid)

***NOTE: The interconnecting copper refrigerant lines shall be supplied by the installer. The larger suction line must be fully insulated along its complete length from condensing unit to fan coil unit. There is a factory-installed liquid line filter-drier inside the condensing unit; therefore, no additional drier is needed for proper operation. A liquid line moisture/sight glass is factory installed in the condensing unit to assist in monitoring the refrigerant charge, and the state of the refrigerant in the system.***

- Keep horizontal and vertical distances between the indoor and outdoor section as close as possible to minimize refrigerant charge required. This will reduce system issues related to oil management that can impair performance and jeopardize the compressor's lubrication.
- Provide a one-inch pitch in suction and liquid line toward the evaporator for every 10 feet (3 meters) of run to prevent any refrigerant that condenses in the suction line from flowing to the compressor when the unit is off. These two lines can be routed together and wrapped together, as long as the suction line is fully insulated as previously directed.
- Suction line riser traps are not required if the riser is properly sized to maintain refrigerant velocity. Adding a trap will only increase pressure drop.
- Prevent dips, sags, or other low spots that will trap refrigerant oil, which is an issue especially with long horizontal runs. Use hard refrigerant copper for longer horizontal runs to prevent potential oil return problems. (see sample piping chart on page 40)
- When sweat connections are made in the connecting lines, be sure that the inside of the tubing is clean before installing the unit. Use a dry nitrogen bleed during brazing. Note that compressor suction and discharge valves should be open to atmosphere no longer than 15 minutes. Compressors with POE (polyolester) oil will quickly become contaminated when opened to atmosphere. On any installation, the use of a suction line filter, liquid line filter drier and moisture indicator is recommended. If the suction line is larger than one-



quarter inch, a vibration eliminator should be installed close to the motor compressor in a horizontal parallel to the compressor, crankshaft or in a vertical position 90 degrees to compressor crankshaft.

**NOTE: The suction line should be clamped near the inlet end of the vibration eliminator. The vibration eliminator is located between the clamp and the compressor.**

**Split System Interconnecting Line Sizing Chart**

Table 3

**60Hz Models**

Model	Liquid Line(OD)	Suction line at Condenser (OD)	Min. Suction line insulation thickness (in)	Suction connection at evaporator (OD)	Maximum "total" line length	Maximum lift (height)
CS025	¼ inches	3/8 inches	3/8 inches	3/8 inches	50 feet	15 feet
CS050	¼ inches	½ inches	3/8 inches	3/8 inches*	50 feet	15 feet

**50Hz Models**

Model	Liquid Line(OD)	Suction line at Condenser (OD)	Min. Suction line insulation thickness (in)	Suction connection at evaporator (OD)	Maximum "total" line length	Maximum lift (height)
WGC60	0.635cm	1.27cm	0.952cm	0.952cm*	15.24 meters	4.57 meters

*\*Use 1/2" (1,27cm) to 3/8" (0.952cm) reducer at evaporator*

**Notes:**

- *Line lengths are expressed in equivalent feet = actual run length + fitting allowances (i.e. ~5' for each bend/elbow allowance).*
- *Use only refrigeration grade dehydrated tubing.*
- *Install refrigeration piping per local codes and ASHRAE guidelines.*

## Sample Piping Configurations

### *Incorrect Installation*

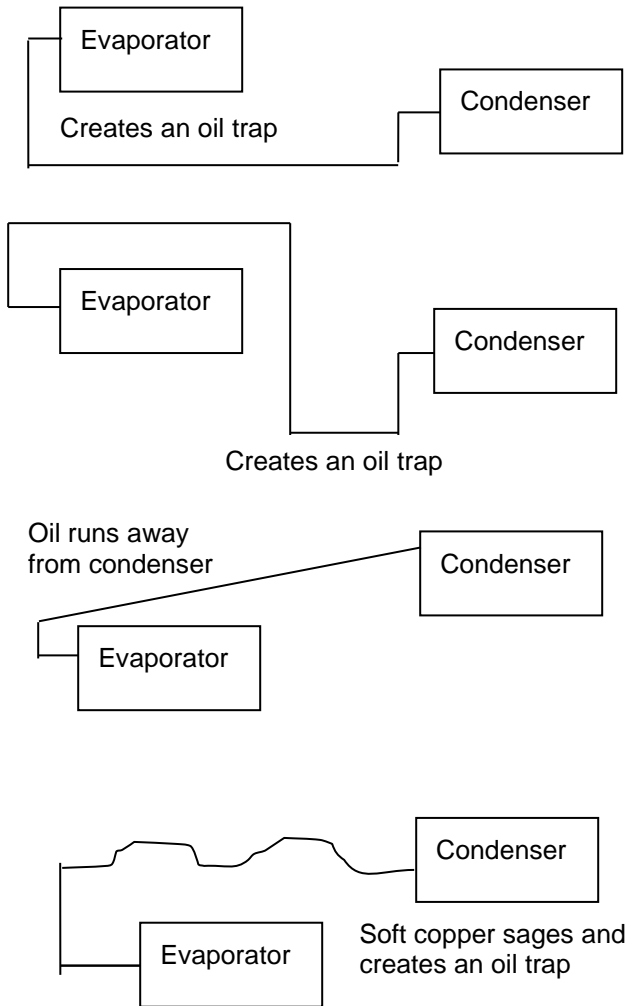

### *Correct Installation*

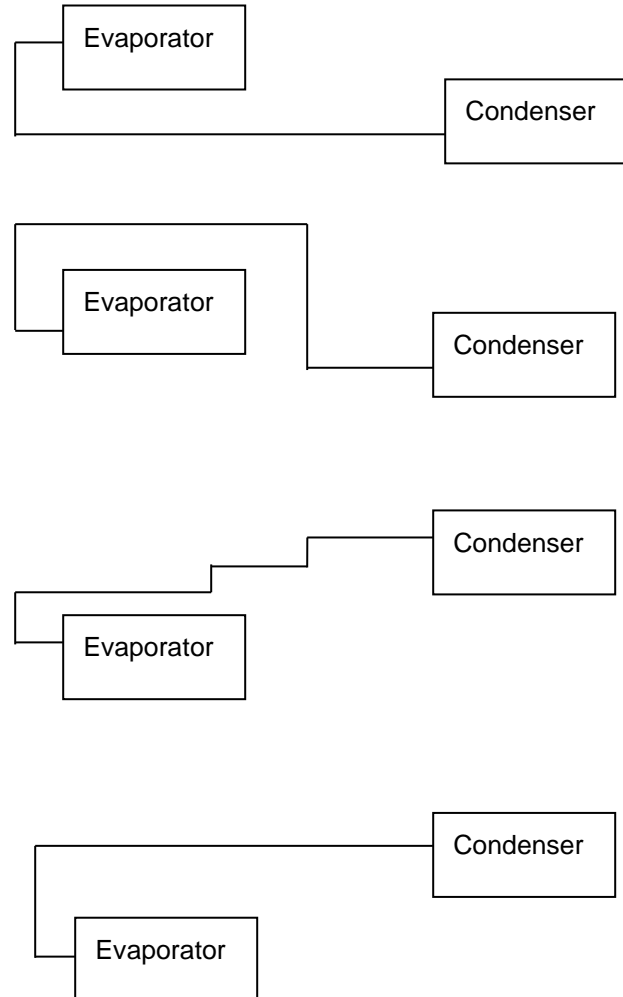

## Leak Checking and Evacuation Process

- Pressurize and leak test the interconnecting lines, including the fan coil unit, fittings, and brazed joints using the intended operating refrigerant, nitrogen, or dry air for leak testing. A pressure equal to the low side test pressure marked on the unit nameplate is recommended for leak testing. Repair any leaks found. Connect a good vacuum pump to both the low and high side service valves while still in their factory supplied position, isolating the refrigerant charge in the condensing unit. Draw a deep vacuum of at least 15pp microns. Do not use the motor compressor to pull a vacuum and do not operate the motor compressor in a vacuum.
- Evacuate the system to hold at 500 microns and break the vacuum by releasing the factory refrigerant charge in the condensing unit to interconnect lines and fan coil unit by opening service valves. Remove the vacuum pump. The system is now ready for optimal charging. Refer to pages 48-49 of this manual. Charge the system with the correct amount of refrigerant and mark the amount, with a ballpoint pen, in the space provided on the unit nameplate.

**See Split System Operations charts on page 50 for approximate system operation based on outdoor ambient at standard wine cellar conditions.**

***NOTE: When charging through the suction service valve the refrigerant should be charged in vapor form. NEVER CHARGE IN LIQUID FORM. Refrigerant should always be charged through a dryer. Charging in liquid form may damage the valve plate assembly as well as scrub the oil out of the compressor bearings.***



**NON-AZEOTROPES MUST BE CHARGED IN THE LIQUID PHASE ONLY. TO AVOID COMPRESSOR DAMAGE, LIQUID MUST ALWAYS BE CHARGED INTO THE HIGH SIDE OR INTO AN ACCUMULATOR.**

***NOTE: Be sure there is not an overcharge of refrigerant. An overcharge might permit liquid refrigerant to enter the motor compressor and damage the valves, rods, pistons, etc.***

### ***Wiring***

- Wire the system as per the supplied wiring schematics starting on page 19 of this manual.
- Run 24-volt power wires from the low voltage terminal block at the fan coil to the terminal block in the junction box in the condensing unit labeled Y & C. This can be typical controller wire or 18-gauge insulated wire. (see Fig.1, 2 & 3 on the following page)

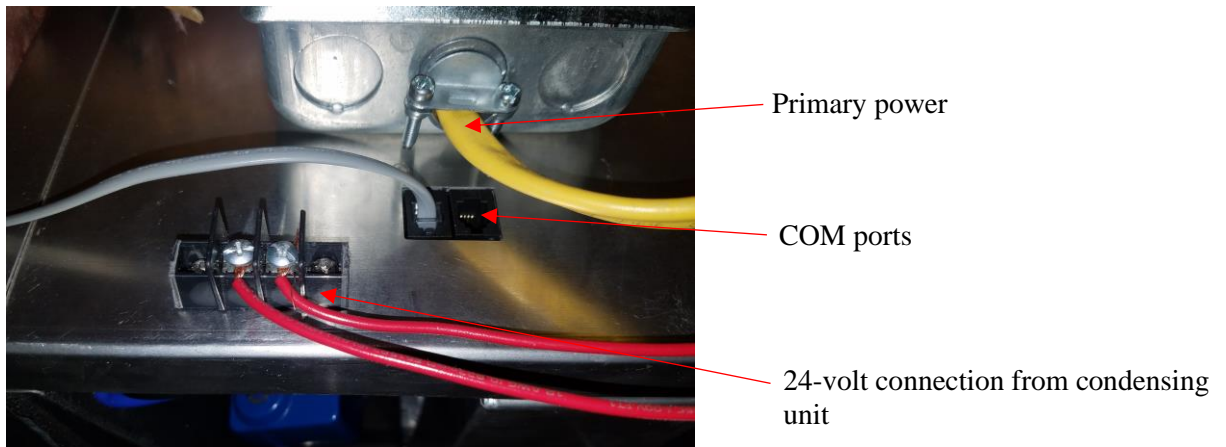

Fig 1



Fig 2



Fig. 3

- The condensing unit needs to be hard-wired for the rated high voltage to be brought to the factory-installed contactor in chassis cabinet to the line side (L1 & L3) of the contactor. Use table 1 to identify the minimum recommended AWG, **USE COPPER WIRE ONLY**. Run a ground lead to be connected to the condensing unit Ground lead/LUG. There is a separate ground lug for the condensing unit internal components (See Fig 3). The load side of the factory-installed contactor will be factory-wired.
- Turn on power to the condensing unit 24 hours prior to system start-up to allow crankcase heater to warm up compressor crankcase.

Condensing Unit	Recommended Minimum AWG
DS025	16
DS050; WGS75	16

## Refrigerant Charging

**NOTE: Models DS, and WGS Condensing Units utilize a Headmaster control valve to control head pressure at low ambient applications, therefore require a specific initial charging procedure as outlined below.**

### **Determining the amount of charge – Low ambient and extreme low ambient (XLA) systems:**

When “refrigerant side” head pressure control is utilized on a system, one of the most important factors is determining the total system refrigerant charge. While on most packaged units the amount of charge is listed on the unit, the required charge for a field built-up system cannot be listed by the manufacturer. Charge is usually added when the system is started up until “proper” system performance is reached. However, this is not satisfactory and if the system is to function properly year-round, the correct amount of extra charge must be calculated ahead of time.

**\*\*SEE PAGES 47-48 FOR DESIGNED AMOUNTS OF REFRIGERANT CHARGE FOR YOUR SPECIFIC MODEL SYSTEM\*\***

## Procedures for Charging System with Head Pressure Control

**NOTE: When charging any system with head pressure control the outdoor ambient temperature must be known.**

### **Charging of Systems with Head Pressure Control in temperatures above 70° F (21°C) --After normal evacuation procedures:**

1. Connect refrigerant cylinder to liquid line service valve port.
2. Charge liquid refrigerant into the high side of the system. Weighing the charge is recommended.
3. Remove the refrigerant drum and connect it to the suction service valve.
4. Charge refrigerant vapor into the low side. Do not allow **liquid** refrigerant into the low side.
5. Start the system.
6. Observe sight glass (factory-installed) to see if system is filling with refrigerant for normal refrigeration cycle.



**BUBBLES IN THE SIGHT GLASS CAN BE CAUSED BY FLASHING DUE TO PRESSURE DROP FROM PIPE OR ACCESSORY LOSSES, ETC.**

7. If the **Sight glass** shows bubbles, more refrigerant may be required, while allowing sufficient time for the refrigerant to stabilize and clear the **Sight glass**. Use supplied information on the following pages for proper final charge.

## Charging of Systems with Sporlan Head Pressure Control in temperatures below 70° F (21°C) (After normal evacuation procedures):

***NOTE: When charging in ambient below 70°F (21°C) the procedure is very critical. Be sure to adhere to the following steps. Failure to do so will result in overcharging the system.***

- 1. You must power the condensing unit up to 24hrs prior to complete system energize to allow compressor oil crankcase to warm. If not done hours in advance of the system/compressor start-up, there is risk of premature compressor failure, that would not be covered under warranty.**
2. Follow instructions 1 through 7 above.
3. If the valve setting is correct for the system being charged, it is quite likely that some refrigerant will be backed up into the condenser and the **Sight glass** will indicate bubbles in the liquid line.
4. Add more refrigerant, while allowing sufficient time for the refrigerant to stabilize and clear the **Sight glass**. Use supplied information on the following pages for proper final charge.
5. At this point the system is correctly charged for this type of head pressure control at the ambient temperature that exists while the charging procedure is taking place.
6. If the system is designed to operate at ambient below the ambient that exists during charging, additional charge may have to be added now.

Good system performance during low ambient operation depends on proper refrigerant charge, therefore, it is very important that this phase of the installation procedure be done carefully. Poor system performance is often caused by over or under charging of refrigerant and may be the most overlooked.

### ***With the system started***

- After following instructions on the previous page Charging for Systems with Head Pressure Control, with refrigerant tank now connected to suction line (low side) port to add remaining charge in a gas state, refer to the provided charts for proper system operating points as equated to ambient temperature with wine cellar at normal conditions of 57° F (13°C) / 55%RH. Refer to Split Systems Operations chart on page 40 for system pressures, sub-cooling, and superheat values to allow you to charge your system correctly.
- In addition to using the Systems Operations Chart, there is a liquid line moisture/sight glass located in the condensing (outdoor) unit as a useful guide to help determine if the system has been sufficiently charged. **HOWEVER**, a full sight glass or a glass with bubbles does not necessarily indicate the system is properly charged or undercharged. There may be other factors affecting sight glass, so do not charge by sight glass method only. A full sight glass- matched with proper system pressures, sub-cooling, and superheat values is the proper method for confirming that the system charge is correct for your application.

***If you are not sure how to measure superheat or sub-cooling:***

***Superheat***

- Get an accurate suction line temperature on the suction line as close to the compressor inlet as possible. At same time, attach a compound pressure gauge set to the system so as to read the low side suction pressure at the suction service valve port (back seated valve stem to allow un-restricted refrigerant flow from evaporator back to the compressor). Convert suction pressure to a saturated temperature as derived from a pressure/temperature chart. Since the suction line temperature is the higher value, subtract the saturated temperature from it to derive your superheat. If your wine cellar is already at specified conditions e.g., 57° F (13°C), 55% RH), and if your superheat is very low, or zero, you may have overcharged your system.

***Sub-Cooling***

- With your compound pressure gauge set still installed with the high side connect to the valve port on the liquid receiver (back seated valve stem to allow un-restricted refrigerant flow from condenser to evaporator). Convert this liquid pressure to a saturated temperature from pressure/temperature chart. Next, obtain your liquid line temperature by getting an accurate reading on the liquid line **BEFORE** the TXV expansion on the indoor side. Obtain this temperature entering the evaporator unit. Subtract the liquid line temperature from the saturated liquid temperature to derive the system sub-cooling.

**Charge Amount:**

For Installations using a line-set distance that are **Less Than or Equal To** 25' add the required amount of refrigerant shown in the table on the next page.

For Installations using a line-set distance that are **Greater Than** 25' add the required amount of refrigerant shown in the table on the next page **THEN** add additional refrigerant based on the rules below:

Models SS018, CS025, DS025, CS050, DS050, WGS25, WGC60, WGS40, and WGS75  
Add an additional 0.50 oz/ft (0.465 kg/meter) for every foot **exceeding** 25'

Models DS088, DS200, WGS100, and WGS175  
Add an additional 1 oz/ft (0.93 kg/meter) for every foot **exceeding** 25'

Assuming a 25' Line-Set Installation				
Model #	Total Charge Required	Holding Charge Present	<b><u>Charge That Must Be Added</u></b>	<b><u>Additional charge to add for XLA<sup>1</sup> option</u></b>
<i>60Hz Models</i>				
SS018	47 oz	16 oz	<b>31 oz</b>	4 oz
CS025	58 oz	16 oz	<b>42 oz</b>	4 oz
DS025	59 oz	16 oz	<b>43 oz</b>	4 oz
CS050	66 oz	16 oz	<b>50 oz</b>	4 oz
DS050	55 oz	16 oz	<b>39 oz</b>	4 oz
DS088	105 oz	16 oz	<b>89 oz</b>	6 oz
DS200	108 oz	16 oz	<b>92 oz</b>	6 oz
<i>50Hz Models</i>				
WGS25	50 oz	16 oz	<b>34 oz</b>	4 oz
WGC60	64 oz	16 oz	<b>48 oz</b>	4 oz
WGS40	58 oz	16 oz	<b>42 oz</b>	4 oz
WGS75	64 oz	16 oz	<b>48 oz</b>	4 oz
WGS100	106 oz	16 oz	<b>90 oz</b>	6 oz
WGS175	110 oz	16 oz	<b>94 oz</b>	6 oz

<sup>1</sup>XLA – Extreme Low Ambient Option

Once the system has been charged, compare the high side system pressure to the “discharge line pressure” found below in the “Split System Operations Chart” for proper operation. If actual discharge pressures do not match the chart, then compare subcooling values as additional charge may be needed.



### Split System Operations Chart

\*\*\* Operation data is based on typical wine cellar conditions of 57°F (14 Deg C)DB/49°F WB (55%RH)

<b>DS025 CU</b>				
<b>OD Ambient (F)</b>	<b>Suction (psig)</b>	<b>Discharge (psig)</b>	<b>Suction Superheat (F)</b>	<b>Sub-cooling (F)</b>
10F -12C	21	100	7 F / 3.89 C	23 F / 12.78 C
40F 4C	24	104	13 F / 7.22 C	24 F / 13.33 C
60F 15C	24	107	22 F / 12.22 C	20 F / 11.11 C
70F 21C	24	108	25 F / 13.89 C	18 F / 10 C
80F 26C	24	108	31 F / 17.22 C	16 F / 8.89 C
100F 37C	27	150	38 F / 21.11 C	19 F / 10.56 C
115F 46C	30	190	40 F / 22.22 C	21 F / 11.67 C
<b>DS050 CU</b>				
<b>OD Ambient (F)</b>	<b>Suction (psig)</b>	<b>Discharge (psig)</b>	<b>Suction Superheat (F)</b>	<b>Sub-cooling (F)</b>
20F -6C	22	96	15 F / 8.33 C	9 F / 5 C
30F -1C	24	100	13 F / -7.22 C	10 F / 5.56 C
50F 10C	26	102	16 F / 8.89 C	19 F / 10.56 C
60F 15C	24	100	21 F / 11.67 C	16 F / 8.89 C
70F 21C	26	98	23 F / 12.78 C	13 F / 7.22 C
80F 26C	27	114	26 F / 14.44 C	15 F / 8.33 C
100F 37C	28	160	32 F / 17.78 C	16 F / 8.89 C
115F 46c	32	208	34 F / 18.89 C	18 F / 10 C
<b>WGS75</b>				
<b>OD Ambient (F)</b>	<b>Suction (psig)</b>	<b>Discharge (psig)</b>	<b>Suction Superheat (F)</b>	<b>Sub-cooling (F)</b>
20F / -6C	26	96	6 F / 3.33 C	23 F / 12.78 C
30F / -1C	26	97	10 F / 5.56 C	23 F / 12.78 C
40F / 4C	26	97	13 F / 7.22 C	21 F / 11.67 C
60F / 15C	26	96	20 F / 11.11 C	15 F / 8.33 C
70F / 21C	26	98	27 F / 15 C	11 F / 6.11 C
80F / 26C	28	116	28 F / 15.56 C	12 F / 6.67 C
100F / 37C	30	167	35 F / 19.44 C	14 F / 7.78 C

## Installing the Thermostat and Communication Cable



The Wine Guardian Wireless-to-base Remote Interface Controller is a combination temperature and humidity controller with single stage cooling, heating and humidity control. Its capacitive touch screen incorporates an on/off switch, adjustment arrows and settings buttons for ease of use and programming. The controller can be installed one of two ways:

**Wired (recommended)** – wired directly to the Wine Guardian unit through an RJ-9 communication cable. 50’ (15.25 meters) of control cable is included with each controller with longer lengths available as an option.

### ***IMPORTANT***

*Whenever possible we strongly suggest wiring the Remote Interface Controller directly to the Wine Guardian unit to avoid periodic battery changes and uninterrupted service.*

**Wirelessly** - connects wirelessly to the Wine Guardian unit by Radio Frequency connectivity through one of twelve selectable channels.

### ***IMPORTANT***

*Wireless installation may result in limited communication range and connectivity issues depending upon building construction and distance between Wine Guardian unit and Remote Interface Controller and/or Remote Sensors.*

The Wine Guardian Wireless-to-base Remote Interface Controller is a configurable device that can be fine-tuned through a series of individual settings. The controller incorporates eight (8) key temperature, humidity and system alarm points. Remote alarm indication is possible through terminal point connections at our main control board.

In most applications, the remote interface controller will be mounted within the wine cellar. The remote interface controller can also be mounted directly outside of the wine cellar or in any other room of the home or building. When mounted outside of the wine cellar, a remote sensor kit or a second wireless remote interface must be purchased and installed within the wine cellar.

### ***IMPORTANT***

*Regardless of wired or wireless each, Wine guardian System can have a maximum of two (2) Remote Interface Controllers and three (3) Remote Sensors.*

### **Additional Remote Interface:**

Prior to adding an additional remote interface to the system, you will have to change setting 30 on the first control to give it a different address. Refer back to page **58** for instructions on how to access the interface Settings, and get to Setting 30 (shown on page 63).

## **Controller Specification**

<b>Application</b>	<b>WG only, single stage cooling or heating Humidification</b>
<b>Programmable</b>	<b>No</b>
<b>Change over</b>	<b>Auto or manual, Fan ON or AUTO</b>
<b>Color</b>	<b>Black (only)</b>
<b>User interface</b>	<b>Touch screen</b>
<b>Auto defrost control</b>	<b>Yes, with Serving temp option</b>
<b>Connection</b>	<b>Communicating – RJ-9 cable</b>
<b>Wireless-to-base communication range</b>	<b>40' line of site</b>
<b>Wireless-to-base channels</b>	<b>12</b>
<b>Remote sensors</b>	<b>Yes, wired or wireless</b>
<b>Temperature adjustment</b>	<b>34 to 97 Deg F (1 to 36 Deg C)</b>
<b>Temperature tolerance</b>	<b>+/- 2 Deg F (+/- 1.1 Deg C)</b>
<b>Humidity adjustment</b>	<b>2% to 93% RH</b>
<b>Humidity tolerance</b>	<b>+/- 10% RH</b>
<b>System temperature diagnostics</b>	<b>Not Available</b>
<b>Alarms</b>	<b>High temp, low temp. High humidity, low humidity. High pressure fault. Condensate, Defrost and Communication error</b>

## Mounting the Remote Interface Controller (Wired)



Fig. 1



Fig. 2



Fig. 3



Fig. 4

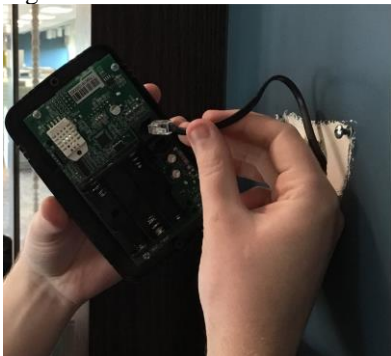

Fig. 5

1. Disconnect the communication cable from the side of the Wine Guardian unit and the remote interface controller. (Fig. 1)
  - a. Route the communication cable within the wall and/or ceiling structure of the wine cellar to the desired controller mounting location.
  - b. Plan on mounting the remote interface controller on a solid surface away from doors, corners, air outlets, drafts or heat generating equipment. Do not mount the remote interface controller directly on an outside wall, a wall adjacent to a boiler room, or other hot area. Use a piece of foam insulation behind the sensor to insulate it from a hot or cold surface. The recommended height is four to five feet above the finished floor.
2. Remove the back plate of the controller (Fig. 2) by removing two (2) screws that hold it in place on the remote interface. Place the back plate against the wall and mark the location of the two mounting points (Fig. 3). Also mark the location of the penetration for the communication cable as this area will require sufficient clearance for the cable to exit the wall and attach to the back of the controller.
3. Drill two one-eighth inch holes and insert anchors at the marked locations. Anchors may not be required if securing to a wall stud or racking system. Insert the screws into the holes and test fit the backing plate to ensure it mounts easily onto the two screws and slides down onto the slotted opening freely (Fig. 4).
4. Re-install plastic face plate on to backing plate.
5. Plug in the communication cable to the back of the remote interface controller backing plate. (Fig. 5)
  - a. If using multiple Remote Interfaces either connect each Sensor to each other in series using RJ-9 cable or purchase a RJ-9 Splitter to be used on the unit.
6. Attach the Controller to the wall
7. Re-attach the communication cable to the side of the Wine Guardian cooling unit.

## Mounting the Remote Interface Controller (Wireless)



Fig. 1



Fig. 2



Fig. 3



Fig. 4

1. Disconnect the controller wire from the side of Wine Guardian unit and save for future use.
2. Plan on mounting the remote interface controller on a solid surface away from doors, corners, air outlets, drafts or heat generating equipment. Do not mount the remote interface controller directly on an outside wall, a wall adjacent to a boiler room, or other hot area. Use a piece of foam insulation behind the sensor to insulate it from a hot or cold surface. The recommended height is four to five feet above the finished floor.
3. Unscrew and remove the back plate from the Remote Interface Controller (Fig. 1)
4. Place the back plate against the wall and mark the mounting points at the desired location. (Fig. 2)
5. Drill two one-eighth inch holes and insert anchors within the mounting surface. Anchors may not be required if securing to a wall stud or racking system. Insert the screws into the holes and test fit the backing plate for mounting to ensure it mounts easily onto the two screws and slides down onto the slotted openings freely (Fig. 3)
6. Reattached the back plate to the Remote Interface Controller. (Fig. 4)
7. Insert the three AA batteries.  
(only applicable with wireless installations)
8. The system will automatically acknowledge a wireless device (Remote Interface or Remote Sensor). Go to Setting "30" to define the Remote User Interface use.
9. Attach controller to the wall.

## Installation of the Wine Guardian Remote Sensor



The wireless remote sensor is a combination temperature and humidity sensor only. It is designed to be mounted within the wine cellar and can be used in combination with the remote interface controller or up to two additional remote sensors to read and control multiple areas within the wine cellar.

For a wired application you will require a RJ-9 communication cable.

### Mounting the Wired Remote Sensor (Wired)



Fig. 1

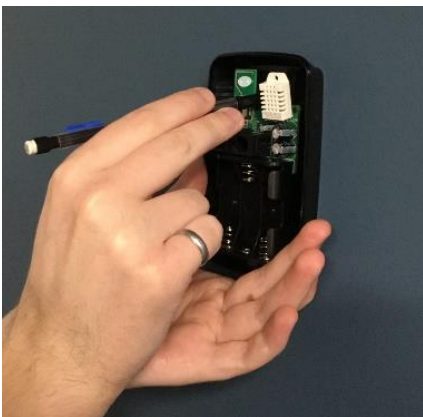

Fig. 2

1. Disconnect the communication cable from the side of the Wine Guardian unit and the remote sensor. Route the communication cable within the wall and/or ceiling structure of the wine cellar to the desired controller mounting location.
2. Plan on mounting the remote sensor on a solid surface away from doors, corners, air outlets, drafts or heat generating equipment. Do not mount the remote sensor directly on an outside wall, a wall adjacent to a boiler room, or other hot area. Use a piece of foam insulation behind the sensor to insulate it from a hot or cold surface. The recommended height is four to five feet above the finished floor.
3. Remove the remote sensor's face plate (Fig. 1) and mark the mounting points at the desired location within the wine cellar (Fig. 2). Also, mark the location of the communication cable connection as this area will require sufficient clearance, for the cable to exit the wall and attach to the back of the sensor.



Fig. 3



Fig. 4



Fig. 5

4. Drill two one-eighth inch holes and insert anchors within the mounting surface. Anchors may not be required if securing to a wall stud or racking system. Insert the screws into the holes and test fit the backing plate for mounting to ensure it mounts easily onto the two screws and slides down onto the slotted openings freely. (Fig. 4)
5. Plug in the communication cable to the remote sensor and mount the Remote Sensor to the wall. (Fig. 4)
6. Reattach the sensor's faceplate (Fig. 5)
7. If multiple sensors are being used either connect each Sensor to each other in series using RJ-9 cable or purchase a RJ-9 Splitter (Fig. 6) to be connected to the unit.

**NOTE:** Remote Sensor's will always be treated as "enabled" when hardwired. Their temperature and humidity readings will always be calculated towards the average by the system.

## Mounting the Remote Sensor (Wireless)



Fig. 1



Fig. 2



Fig. 3



Fig. 4



Fig. 5

1. Disconnect the controller wire from the side of Wine Guardian unit and save for future use.
  2. Plan on mounting the remote sensor on a solid surface away from doors, corners, air outlets, drafts or heat generating equipment. Do not mount the remote sensor directly on an outside wall, wall adjacent to a boiler room, or other hot area as this runs the risk of influencing its temperature readings. The recommended height is four to five feet above the finished floor.
  3. Remove the sensor face plate (Fig. 1). Mark the mounting points at the desired location within the wine cellar (Fig. 2).
  4. Drill two one-eighth inch holes and insert anchors within the mounting surface. Anchors may not be required if securing to a wall stud or racking system. Insert screws to secure the sensor to the wall to ensure it mounts easily onto the two screws and slides down onto the slotted openings freely.
  5. Input the three AA batteries. (Fig. 3)  
(only applicable with wireless installations)
  6. Pair the sensor with the unit  
(See Page 46 for Pairing Instructions)
- NOTE: Once Paired the Remote Interface's readings will be included into the system's temperature and humidity averages.***
7. Mount the Remote Sensor on the wall (Fig. 4)
  8. Reattach the sensor's faceplate (Fig. 5)



## Remote Sensor Pairing Instructions –Multiple Sensors (Wireless)



Fig. 1



Fig. 2

If using multiple remote temperature/humidity sensors in your application, refer to the figures and the procedure below to change each remote sensor's device number (Three Remote Sensors maximum). Each Remote Sensor must have its own device number and must also be on the same RF channel (Setting 31) as the system they are being paired with.



1. To change the remote sensor's device number, see the following instructions:
  - a. Use a pin to press the button for about half a second and release (Fig. 1).
  - b. Observe the LED on the side of the remote sensor (Fig. 2). The LED will flash once for a Device #1, twice for a #2, three times for a #3. At any time, while in this mode press the button once to change the device number. Once each remote sensor has its own unique device number simply wait for the LED to stop flashing and the setting will be saved.
2. To change the remote sensor's RF channel, see the following instructions:

***NOTE: Check what RF Channel the System is set to using Setting 31 to more easily connect your Remote Sensors.***

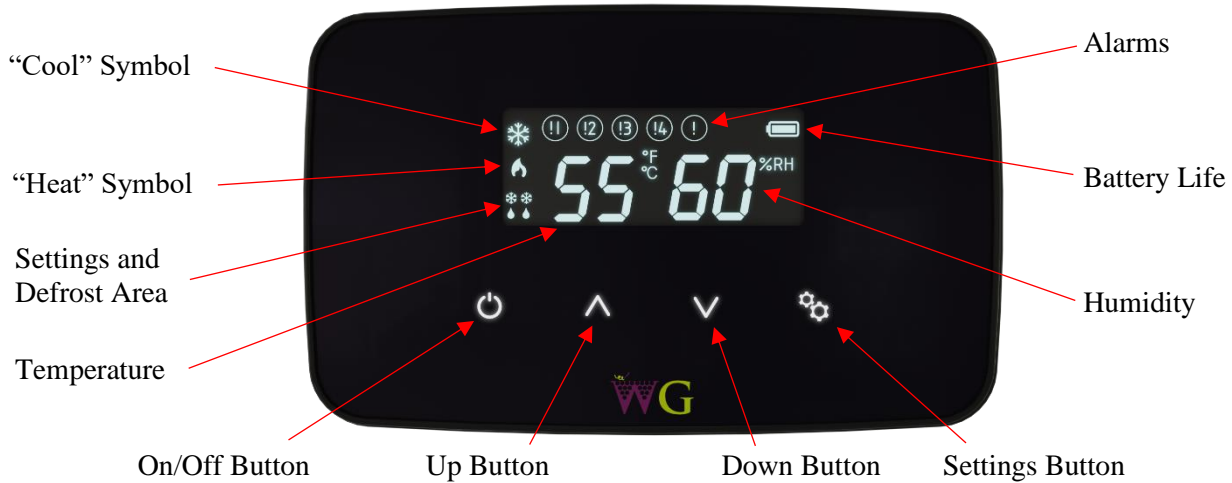

- a. Use a pin to press the red button at the back of the Remote Sensor for 5 seconds until the LED blinks rapidly then release the button.
- b. The LED will flash a number of times to portray which RF channel it is set to and repeat a total of 3 times.
- c. To change the RF channel, press the button once to increment the RF channel. There are 12 possible RF channels. All Remote Sensors will need to be on the same channel for the system to detect them. To save the RF channel setting simply wait for the mode to time out by not pressing the button.

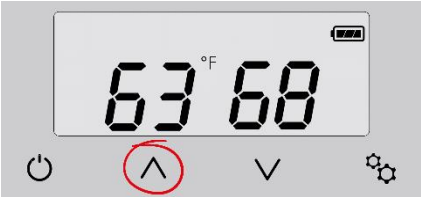

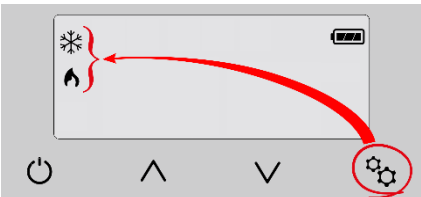

# Standard Controller Functions

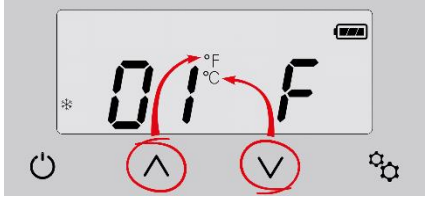

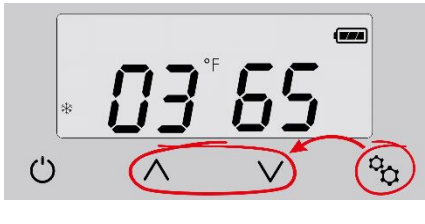
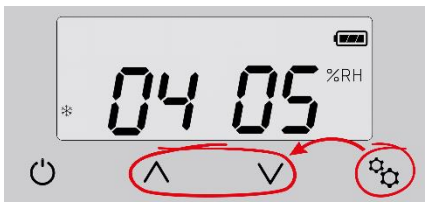
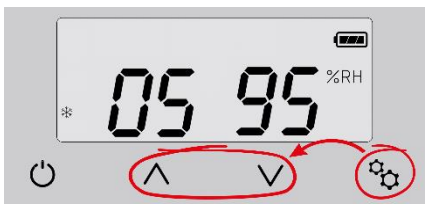
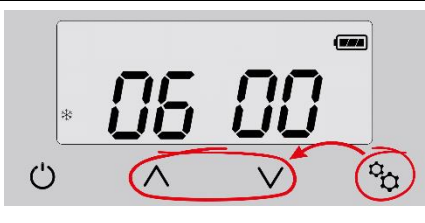





<i>How to:</i>		
<p><b>Turn system on/off</b></p>		<ul style="list-style-type: none"> <li>Press the “On/Off” button once.</li> </ul> <p><b>Note: There is a five (5) minute time delay before the system turns on or turns off.</b></p>
<p><b>Change temperature</b></p>		<ul style="list-style-type: none"> <li>Press the “Up” arrow once. The display will show the existing temperature setpoint.</li> <li>Press the up or down arrow buttons to adjust the temperature to the desired set point.</li> </ul>
<p><b>Change humidity</b></p>		<ul style="list-style-type: none"> <li>Press the “Up” arrow once. This display will show the existing temperature setpoint.</li> <li>Press the “Settings” button once to display the “Humidity” setpoint.</li> <li>Press the “Up” or “Down” arrows to adjust the humidity to the desired set point.</li> </ul> <p><b>Note: A Wine Guardian humidifier must be installed and Setting 6 set to “1” or “2” before the controller will let you change percent humidity.</b></p>
<p><b>Change Settings Cooling/ Heating / Auto</b></p>		<ul style="list-style-type: none"> <li>Press the Setting button once to display the setting function at the bottom of the screen.</li> <li>Press the Settings button again to scroll through settings for cool only, heat only or heat/cool only – auto mode.</li> </ul>



**Settings – Press and hold the “Settings” button for five (5) seconds to access the following settings.**

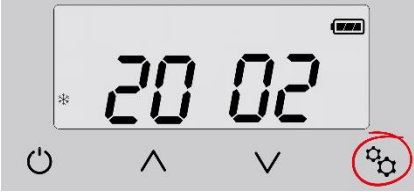

<p><b>Degrees F or Degrees C</b></p>		<p><b>Setting 1</b></p> <ul style="list-style-type: none"> <li>• Press the “Up” arrow to change temperature from °F to °C.</li> <li>• Press the “Down” arrow to change temperature from °C to °F.</li> </ul>
<p><b>Low temperature alarm setpoint</b></p>		<p><b>Setting 2</b></p> <ul style="list-style-type: none"> <li>• Press “Settings” button to advance to Setting 2.</li> <li>• Press the “Up” or “Down” arrow buttons to adjust to the desired setpoint. Factory default is 50°F (10°C).</li> </ul>
<p><b>High temperature alarm setpoint</b></p>		<p><b>Setting 3</b></p> <ul style="list-style-type: none"> <li>• Press “Settings” button to advance to Setting 3.</li> <li>• Press the “Up” or “Down” arrow buttons to adjust to the desired setpoint. Factory default is 65°F (18°C).</li> </ul>
<p><b>Low humidity alarm set point</b></p>		<p><b>Setting 4</b></p> <ul style="list-style-type: none"> <li>• Press “Settings” button to advance to Setting 4.</li> <li>• Press the “Up” or “Down” arrow buttons to adjust to the desired setpoint. Factory default is 5%.</li> </ul>
<p><b>High humidity alarm setpoint</b></p>		<p><b>Setting 5</b></p> <ul style="list-style-type: none"> <li>• Press “Settings” button to advance to Setting 5.</li> <li>• Press the up or down arrow buttons to adjust to the desired setpoint. Factory default is 95%.</li> </ul>
<p><b>Add or remove humidifier</b></p>		<p><b>Setting 6</b></p> <ul style="list-style-type: none"> <li>• Press “Settings” button to advance to Setting 6.</li> <li>• Press the “Up” or “Down” arrow buttons to adjust to the desired setpoint. Factory default is zero (0).</li> </ul> <p>Zero (0) = No humidifier  One (1) = Integral Wine Guardian mounted humidifier  Two (2) = Stand-alone remote mounted humidifier</p>

<p><b>Fan AUTO or ON</b></p>		<p><b>Setting 7</b></p> <ul style="list-style-type: none"> <li>• Press “Settings” button to advance to Setting 7.</li> <li>• Press the “Up” or “Down” arrow buttons to adjust number to the desired set point. Factory default is zero (0).</li> </ul> <p>Zero (0) = Auto–fan only turns on when there is a call for cooling or heating</p> <p>One (1) = Fan On–fan remains on continuously</p>
<p><b>Compressor anti-short cycling</b></p>		<p><b>Setting 8</b></p> <ul style="list-style-type: none"> <li>• Press “Settings” button to advance to Setting 8.</li> <li>• Press the “Up” or “Down” arrow buttons to adjust to the desired time in one-minute increments. Maximum is 10 minutes, minimum is 3 minutes. Factory default is 5 minutes.</li> </ul> <p>Compressor anti-short cycling time is the amount of allowable time between compressor stop and restart. Rapid start/stop of compressors can cause premature failure.</p> <p><b>WINE GUARDIAN DOES NOT RECOMMEND SETTINGS LOWER THAN FACTORY DEFAULT.</b></p>
<p><b>Defrost sensor enable/disable</b></p>		<p><b>Setting 9</b></p> <ul style="list-style-type: none"> <li>• Press “Settings” button to advance to Setting 9.</li> <li>• Press the “Up” or “Down” arrow buttons to adjust to the desired setpoint.</li> </ul> <p>1 will equal enabled and a 0 (zero) will equal disabled.</p>
<p><b>Defrost cut-in temperature</b></p>		<p><b>Setting 10</b></p> <ul style="list-style-type: none"> <li>• Press "Settings" button to advance to Setting 10.</li> <li>• Press the “Up” or “Down” arrow buttons to adjust to the desired setpoint. This setting is adjustable from 25°F to 40°F. Factory default is 39°F.</li> </ul> <p>There must be at least a 1°F difference between defrost cut-in and cut-out set points.</p>

<p><b>Defrost cut-out temperature</b></p>	 <p>The image shows a digital display with the number '11 40'. Below the display are four buttons: a power button on the left, an up arrow button, a down arrow button, and a settings gear icon on the right. Red circles highlight the up and down arrow buttons, and a red arrow points from the settings gear icon to the down arrow button.</p>	<p><b>Setting 11</b></p> <ul style="list-style-type: none"> <li>• Press "Settings" button to advance to Setting 11.</li> <li>• Press the "Up" or "Down" arrow buttons to adjust to the desired setpoint. This setting is adjustable from 35°F to 50°F. Factory default is 40°F.</li> </ul> <p><b>Note: This setpoint must be 1°F/°C higher than setting 10.</b></p> <p><b>Note: If °C is selected and then switched back to °F the default cut-out will change to 41°F.</b></p>
<p><b>Defrost check interval</b></p>	 <p>The image shows a digital display with the number '12 01'. Below the display are four buttons: a power button on the left, an up arrow button, a down arrow button, and a settings gear icon on the right. Red circles highlight the up and down arrow buttons, and a red arrow points from the settings gear icon to the down arrow button.</p>	<p><b>Setting 12</b></p> <ul style="list-style-type: none"> <li>• Press "Settings" button to advance to Setting 12.</li> <li>• Press the "Up" or "Down" arrow buttons to adjust to the desired setpoint. This setting is adjustable from 30 min at 0 (zero), 1 hour at 1, and then in 1 hour increments up to a maximum of 12 hours at 12.</li> </ul>
<p><b>Room temperature offset</b></p>	 <p>The image shows a digital display with the number '13 00'. Below the display are four buttons: a power button on the left, an up arrow button, a down arrow button, and a settings gear icon on the right. Red circles highlight the up and down arrow buttons, and a red arrow points from the settings gear icon to the down arrow button.</p>	<p><b>Setting 13</b></p> <ul style="list-style-type: none"> <li>• Press "Settings" button to advance to Setting 13.</li> <li>• Press the "Up" or "Down" buttons to adjust to the desired set point. Maximum setting is +5°F, minimum setting is -5°F. Factory default is zero (0).</li> </ul> <p>Room temperature offset changes the actual display reading (temperature only) by the value of this setting.</p> <p>Example: Sensor reading = 55°F (13°C)  Setting 13 set to +4  Display reading = 59°F (15°C)</p>
<p><b>RH offset</b></p>	 <p>The image shows a digital display with the number '14 00' and '%RH' to the right. Below the display are four buttons: a power button on the left, an up arrow button, a down arrow button, and a settings gear icon on the right. Red circles highlight the up and down arrow buttons, and a red arrow points from the settings gear icon to the down arrow button.</p>	<p><b>Setting 14</b></p> <ul style="list-style-type: none"> <li>• Press "Settings" button to advance to Setting 14</li> <li>• Press the "Up" or "Down" buttons to adjust to the desired setpoint. This setting allows the adjustment of %RH reading by +/-10%. Factory default is 0%RH.</li> </ul>

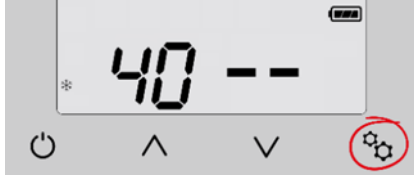
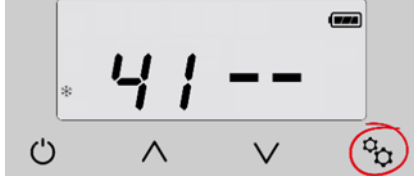
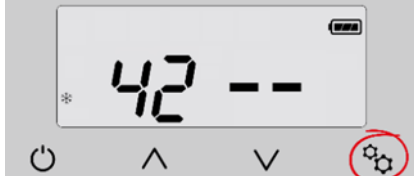
<b>Differential temperature adjustment</b>		<b>Setting 15</b> <ul style="list-style-type: none"> <li>• Press “Settings” button to advance to Setting 15</li> <li>• Press the “Up” or “Down” buttons to adjust to the desired setpoint. This setting changes the system/compressor turn-on temperature above setpoint. Factory default is 1°F.</li> </ul> <p>Example: Sensor reading = 55°F (13°C)  Setting 15 set to +3°F  System/compressor turns on at 58°F (14°C)</p>
<b>Temperature deadband</b>		<b>Setting 16</b> <ul style="list-style-type: none"> <li>• Press “Settings” button to advance to Setting 16.</li> <li>• Press the “Up” or “Down” buttons to adjust to the desired setpoint. This setting is the minimal allowable temperature difference between heating and cooling setpoints. Maximum is 5°F (3°C), minimum is 1°F (1°C). Factory default is 2°F (1°C).</li> </ul>
<b>Condensate switch</b>		<b>Setting 17</b> <ul style="list-style-type: none"> <li>• Press “Settings” button to advance to Setting 17.</li> <li>• Press the “Up” or “Down” buttons to adjust to the desired setpoint. This setting disables or enables the Condensate switch. 0 (zero) is disabled, 1 is enabled. Factory default is 0.</li> </ul>
<b>Reserved</b>		<b>Settings 18 &amp; 19</b> Reserved for additional fields.
<b>System type defaults</b>		<b>Setting 20</b> System setting. <b>DO NOT CHANGE.</b>
<b>Reserved</b>		<b>Settings 21-29</b> Reserved for additional fields.

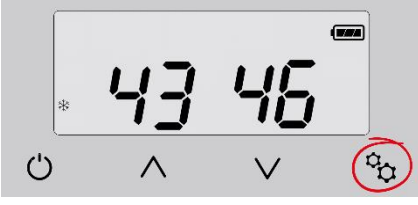
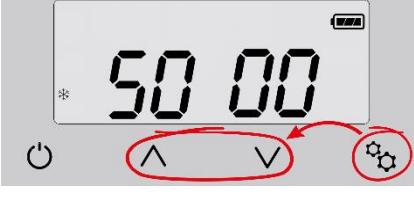
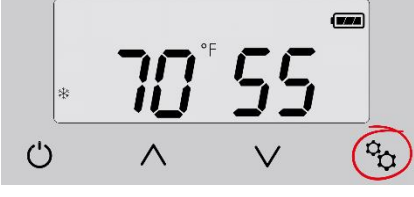
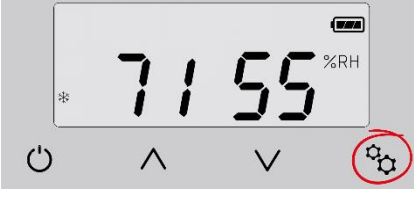
<p><b>Define remote user interface</b></p>		<p><b>Setting 30</b></p> <ul style="list-style-type: none"> <li>• Press “Settings” button to advance to Setting 30</li> <li>• Press the “Up” or “Down” buttons to adjust to the desired setpoint.</li> </ul> <p>1 = Remote User interface #1 mounted within the wine room space and enabled</p> <p>2 = Remote User interface #2 mounted within the wine room space and enabled</p> <p>3 = Remote User Interface #1 disabled - will display only and can be mounted outside of wine room</p> <p>4 = Remote User Interface #2 disabled - will display only and can be mounted outside of wine room</p>
<p><b>RF channel select</b></p>		<p><b>Setting 31</b></p> <ul style="list-style-type: none"> <li>• Press “Settings” button to advance to Setting 31.</li> <li>• Press the “Up” or “Down” buttons to adjust to the desired setpoint.</li> </ul> <p>Each system needs all devices to be on the same RF channel.</p> <p>0 = RF disabled - system must be hardwired</p> <p>1 through 12 = RF enabled and 12 channels available</p>
<p><b>Reserved</b></p>		<p><b>Settings 32-39</b></p> <p>Reserved for additional fields.</p>
<p><b>Thermistor 1</b></p>		<p><b>Setting 40</b></p> <ul style="list-style-type: none"> <li>• Press “Settings” button to advance to Setting 40.</li> </ul> <p>Not Available</p> <p>Reserved for Thermistor</p>
<p><b>Thermistor 2</b></p>		<p><b>Setting 41</b></p> <ul style="list-style-type: none"> <li>• Press “Settings” button to advance to Setting 41.</li> </ul> <p>Not Available</p> <p>Reserved for Thermistor</p>
<p><b>Thermistor 3</b></p>		<p><b>Setting 42</b></p> <ul style="list-style-type: none"> <li>• Press “Settings” button to advance to Setting 42.</li> </ul> <p>Not Available</p> <p>Reserved for Thermistor</p>

<b>Thermistor 4</b>		<b>Setting 43</b> <ul style="list-style-type: none"> <li>Press “Settings” button to advance to Setting 43.</li> </ul> <p>No setting adjustment.</p> <p>Displays the defrost sensor temperature.</p>
<b>Reserved</b>		<b>Setting 44-49</b> Reserved for additional fields.
<b>Output test</b>		<b>Setting 50</b> <ul style="list-style-type: none"> <li>Press “Settings” button to advance to Setting 50.</li> <li>Press the “Up” or “Down” buttons to adjust to the desired setpoint.</li> </ul> <p>Steps through relays as output test.</p> <p>0 = Disabled  1 = Enabled</p>
<b>Reserved</b>		<b>Setting 51-69</b> Reserved for additional fields.
<b>Default temperature</b>		<b>Setting 70</b> <ul style="list-style-type: none"> <li>Press “Settings” button to advance to Setting 70.</li> </ul> <p>No setting adjustment.</p> <p>Initial temperature set point. Will revert to this setting upon loss of power.</p>
<b>Default %RH</b>		<b>Setting 71</b> <ul style="list-style-type: none"> <li>Press “Settings” button to advance to Setting 71.</li> </ul> <p>No setting adjustment.</p> <p>Initial relative humidity set point. Will revert to this setting upon loss of power.</p>
<b>Default mode</b>		<b>Setting 72</b> <ul style="list-style-type: none"> <li>Press “Settings” button to advance to Setting 72.</li> <li>Press the “Up” or “Down” buttons to adjust to the desired setpoint.</li> </ul> <p>Initial mode set point. Will revert to this setting upon loss of power.</p> <p>1 = Auto  2 = Cool  3 = Heat</p>

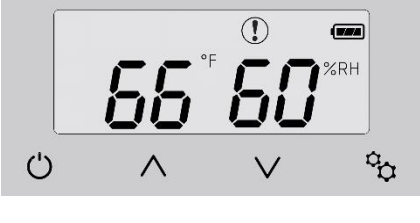
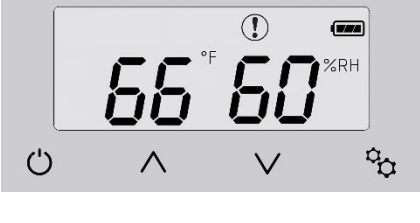
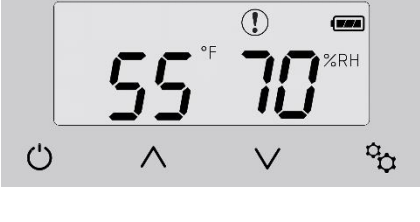
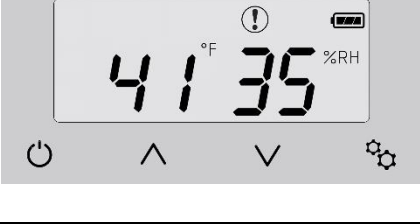
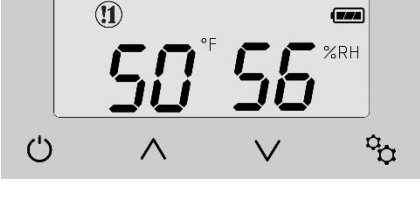
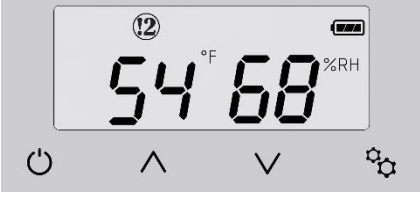

**Alarm Codes**

<p><b>High temperature alarm</b>  <b>Flashing temperature number</b></p>		<p>Flashing temperature number along with (!) symbol will remain on screen until temperature falls below the High Temperature Alarm set point (Setting 3).</p>
<p><b>Low temperature alarm</b>  <b>Flashing temperature number</b></p>		<p>Flashing temperature number along with (!) symbol will remain on screen until temperature rises above the Low Temperature Alarm set point (Setting 2).</p>
<p><b>High humidity alarm</b>  <b>Flashing humidity number</b></p>		<p>Flashing humidity number along with (!) symbol will remain on screen until humidity falls below the High Humidity Alarm setpoint (Setting 5).</p>
<p><b>Low humidity alarm</b>  <b>Flashing humidity number</b></p>		<p>Flashing humidity number along with (!) symbol will remain on screen until humidity rises above the Low Humidity Alarm set point (Setting 4).</p>
<p><b>!1 = High Pressure Switch Fault</b></p>		<p><b>THIS ALARM FORCES THE SYSTEM TO SHUT DOWN</b></p> <p>(!1) will remain on screen until the High Pressure reset switch has been reset.</p> <p>See the trouble shooting guide page 57 for “Instructions to Reset High Pressure Switch”.</p>
<p><b>!2 = CS (Condensate Switch Fault)</b></p>		<p><b>THIS ALARM FORCES THE SYSTEM TO SHUT DOWN</b></p> <p>(!2) will remain on screen until the CS (condensate switch) fault is resolved and reset.</p>

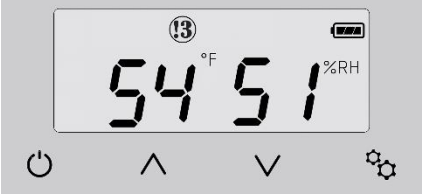
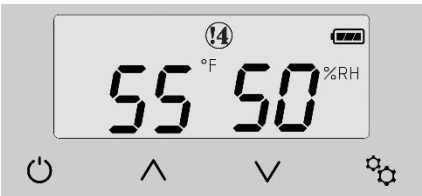
<p><b>!3 = Defrost Sensor Fault</b></p>		<p><b>THIS ALARM FORCES THE SYSTEM TO SHUT DOWN</b></p> <p>Defrost sensor has been shorted, disconnected or open.</p> <p>(!3) will remain on screen until the defrost sensor issue has been resolved.</p>
<p><b>!4 = Communication loss</b></p>		<p><b>THE SYSTEM REMAINS OPERATIONAL DURING THIS ALARM</b></p> <p>Bad or no data transfer between sensing device and main control board.</p> <p>“!4” will remain on screen until communication is re-established.</p>

**!WARNING!**

**Only one Unit can be set up at a time. Ensure other units are unplugged while pairing a unit to ensure there are no communication issues between Wine Guardian Units**

## Inspection and Start Up Checklists

### Receiving and Inspecting

- ✓ Unit received undamaged
- ✓ Unit received complete as ordered including accessories

### Handling and Installing

- ✓ Unit mounted on solid level surface
- ✓ Sufficient space allowed for access to unit and accessories
- ✓ Proper electrical service provided
- ✓ Water provided to optional humidifier
- ✓ Drain lines installed properly
- ✓ The mounting area sufficiently insulated to protect the wine room and ceiling system from condensation
- ✓ No obstructions to air flow around condensing unit

### Starting-up the Unit

- ✓ General visual inspection looks good.
- ✓ All wiring connections checked
- ✓ All grilles and panels in place
- ✓ Start unit
- ✓ Confirm condenser airflow is unrestricted
- ✓ Verify cooling and heating operation
- ✓ Check for excessive noise or vibration



# WG SPLIT SYSTEM START-UP CHECKLIST

## System Information

Fan Coil Serial Number: (Located to the right of the main control panel)	Condenser Serial Number: (Label located near refrigerant piping)
---	---

## Customer Information

First Name:		Last Name:	
Address:		City:	
State:	Zip:	Date of Purchase:	
Email:		Phone #:	

## Installer Information

Company Name:		License#	Date of Startup:
Address		Technician:	
City		Certification ID Number	
State:	Zip:	Certification Source (e.g. NATE):	
Company Phone #:		Technician Phone #:	
Company Email:		Technician Email:	

**Email completed form to [service@wineguardian.com](mailto:service@wineguardian.com)**

<b>Pre-Start-Up</b>		
Is there any shipping damage? If so, Where?		
Will this damage prevent unit start-up?		
Check power supply. Does it agree with unit?		
Has the ground wire been connected?		
Has the circuit protection been sized and installed properly?		
Are the power wires to the unit sized and installed properly?		
Have compressor hold down bolts been loosened (snubber washers are snug, but not tight)?		
<b>Controls</b>		
Are thermostat and indoor fan control wiring connections made and checked?		
Are all wiring terminals (including main power supply) tight?		
Has crankcase heater been energized for 24 hours?		
<b>Indoor Unit</b>		
Has water been placed in drain pan to confirm proper drainage?		
<b>Piping</b>		
Have leaks checks been made at compressor, outdoor and indoor coils, TXVs (Thermostatic Expansion Valves), Filter Driers, with a leak detector?		
Locate, Repair, and Report any leaks.		
Have service valves been opened?		
<b>Check Voltage</b>	L1:	L3:
<b>Start-up</b>		
After at least 10 minutes running time, record the following measurements		
Suction Pressure:		
Suction line temperature:		
Discharge pressure:		
Discharge line temperature:		
Entering outdoor unit air temperature:		
Leaving outdoor unit air temperature:		
Indoor unit enter-air DB (dry bulb) temperature:		
Indoor unit leaving-air WB (wet bulb) temperature:		
Indoor unit leaving-air DB (dry bulb) temperature:		
Indoor unit leaving-air WB (wet bulb) temperature:		
Compressor Amps		

## Starting-up and Operating the Wine Guardian Split System

Now that the installation is complete, check to make sure all plumbing and electrical connections are secure.

Replace all panels that were removed during installation. Make sure the ceiling grille is installed and retaining clips pushed in and secure.



**CAUTION**

**RISK OF PERSONAL INJURY  
COVER ALL OPENINGS OF THE UNIT TO PREVENT A HAND OR FINGER FROM ACCESS  
INSIDE THE UNIT.**

### Turn on the Unit

Turn circuit breakers ON. Turn the Remote Interface Controller on by pushing the on/off button at the controller. The controller will light up to indicate power to the unit. Push the up arrow key to check the temperature set point. A snowflake in the upper left corner of the screen should start to flash. The unit may not come on right away due to the timer built into the circuiting to prevent short-cycling. The snowflake will turn solid when the Condensing Unit turns on and starts to cool the room.

### Testing the Fan

#### **(Configuration Setting 7)**

Factory default is “AUTO” fan operation. To change the fan setting, refer to page 59 of this manual.

- ✓ ON means the fan runs continuously and indicates that the power is on and the control circuit is energized and operating.
- ✓ AUTO means the fan runs only when the remote interface controller is calling for cooling, heating, or the humidistat is calling for humidification.

### Running the Unit

- ✓ Check unit to confirm the compressor is running, such as the hum of the compressor or cool air leaving the ceiling unit.
- ✓ Check for any unusual noise or vibration, such as clanking or rubbing.

Initially, the unit may run continuously for several hours, up to a day or more, while it lowers the cellar temperature. Once the unit reaches the setpoint temperature, it shuts off and starts to cycle on and off as it continues to lower the bottle temperature to the setpoint. The cellar air reaches set point before the bottles. If the cellar temperature started at 75°F (23° C) the supply air temperature discharged from the unit will probably be 12 degrees to 15 degrees colder. As the cellar temperature decreases to 55°F (13°C) the supply temperature differential decreases 8 to 12 degrees colder.

***NOTE: Temp flashes when cellar temperature rise above 65° F (18°C).  
See page 64 for Hi Temp Alarm details.***

## **Cycling the Unit**

The fans continue to free-wheel for several minutes when the unit cycles off. This is normal. If the unit is furnished with an Xtreme low ambient control, the condenser fan also cycles on and off during cooling. This maintains the head pressure on the compressor under Xtreme low ambient conditions and is normal. The bottom of the compressor stays warm even when the unit is off to keep the lubricating oil warm and separated from the refrigerant.

## **Setting the Remote Interface Controller**

Normal settings are between 54 and 58 Deg F (12-14 Deg C).

## **Regulating the Wine Cellar Temperature**

Wine cellars have a natural temperature gradient of approximately 5 to 10 degrees between floor and ceiling. To increase or decrease the temperature in various zones, change the air flow patterns.

To keep the entire wine cellar at the same temperature, set the remote interface controller to run the supply fan continuously and not just when the cooling is operating. Set Setting 7 to Setting 1.

***NOTE: To monitor the Cellar Temperature, place thermometers in various locations in the cellar to monitor the temperature zones.***

# Maintenance

## General



**BEFORE PERFORMING MAINTENANCE ON THE UNIT, READ AND UNDERSTAND THE SAFETY INFORMATION CONTAINED WITHIN THE SAFETY CHAPTER OF THE WINE GUARDIAN MANUAL.**



**HIGH VOLTAGE - RISK OF SERIOUS INJURY OR DEATH  
HIGH VOLTAGES ARE PRESENT IN THE CABINETS. TURN OFF ALL POWER. USE THE LOCKOUT/TAGOUT PROCEDURE BEFORE OPENING PANELS.**



**SHARP EDGES  
RISK OF SERIOUS INJURY  
SHARP EDGES ARE PRESENT ON THE FAN WHEELS, HOUSING, FINS AND COILS.**

***NOTE: Maintenance on Wine Guardian units requires working with high voltage and sheet metal with possible sharp edges. Only qualified personnel should perform maintenance. Some tasks require knowledge of mechanical and electrical methods. Make sure you are familiar with all hazards, general safety related procedures, and safety labels on the unit.***

**EXPOSURE TO MICROBIAL GROWTH (MOLD) CAN CAUSE SERIOUS HEALTH PROBLEMS**

***NOTE: Standing water in drain pans promote microbial growth (mold) that cause unpleasant odors and serious health-related indoor air quality problems. If mold is found, remove it immediately and sanitize that portion of the unit.***

The Wine Guardian is designed for minimum maintenance. The refrigerant system is hermetically sealed and requires no maintenance. The fans are permanently lubricated and require no maintenance. Some maintenance to the unit may be required due to dust or dirt in the air stream.



**SHARP EDGES RISK OF SERIOUS INJURY  
SHARP EDGES ARE PRESENT ON THE FINS AND COILS.**



## Cleaning the Condensate Drain System

The condensate drain system traps dust and dirt. Clean the drain system once a year.

1. Shut off the circuit breakers that power the ceiling unit and condensing unit.
2. Remove the ceiling grille by prying open the two (2) retaining clips. Allow the grille to swing down and away from the unit.



3. Loosen and remove the condensate drain pan retaining screw at the hinged end of the unit. Set aside to re-install once the drain has been cleaned.

4. Remove the condensate drain pan by swinging it down and away from the slot at the end of the pan. Take caution as there may be residual condensate in the pan. Have a bucket ready to empty the pan once the retaining screw is removed from the ceiling unit.

**Note: the drain pan will not fully pull away from the ceiling unit until the pump pick-up (tube and control cable) is disconnected from the system.**



5. Pull tube out of its connection at the pick-up and disconnect control cable from the side of the pump as shown. The pan should now be free from the ceiling unit.

6. If drain pan appears soiled, pour some hot water mixed with liquid bleach (diluted solution) along the length of the pan to remove dirt and debris
7. Continue this treatment until the drain appears clean and free of dirt.
8. Inspect the pump pick up for any blockages or any obvious signs of damage



9. Reinstall the condensate pan by re-installing the pick-up tube and re-connecting the control cable.

10. Insert the slotted end of the condensate drain pan into the support fitting and swing the pan up so that the hole at the opposite end of the slot lines up with the hole in the ceiling system chassis.

11. Insert the retaining screw and tighten.

12. Swing the ceiling grille up into place and push the retaining clips in so that they are secure.
13. Turn on the circuit breakers for the ceiling unit and the condensing unit. Turn on system at Remote Interface Controller

### **Cleaning the Humidifier (optional)**

If the unit was furnished with a humidifier it requires periodic maintenance. Follow the instructions in the humidifier guide.

### **Heating Coil Option**

The heating coil is located between the evaporator coil and blower inside the ceiling chassis. It contains the heating element and high temperature limit switches. The heating coil is wired to work in conjunction with the remote interface controller. Since the remote interface controller prevents the heating and cooling circuits from being energized at the same time, no additional power wiring is needed. We do recommend using the AUTO mode on the remote interface controller so it can switch from heating to cooling automatically. If using either the heat or cool only mode, the remote interface controller will **not** switch automatically.

No additional maintenance is required for the heating coil. To test the heating coil operation, set the remote interface controller on HEAT and set the temperature above the cellar temperature. The supply air temperature should rise above the return air temperature by an amount shown in the specifications.

## Maintenance Schedule

### Monthly

(or quarterly depending on experience with individual cellar) Check and drain trap – clean if needed.

- ✓ Check for noise or vibration.
- ✓ Check for short-cycling of the unit – a turning on and off of the compressor unit more than eight times/hour.

### Yearly

(in addition to monthly)

- ✓ Check evaporator and condensing unit for dirt – use a vacuum with a brush attachment to clean the coils.
- ✓ Clean condensate pan under the evaporator coil by flushing. Be careful to keep the drain pans clear of any and all debris.
- ✓ Inspect cabinet for corrosion or rusting – clean and paint.
- ✓ Inspect for dirt buildup on or inside the unit. Clean unit by vacuuming or wiping it down.
- ✓ Check for loose insulation, fasteners, gaskets or connections.
- ✓ Check the wiring connections and integrity of cords.
- ✓ Examine ducts for any cracks or breach.
- ✓ Check fan and solenoid on humidifier.
- ✓ Replace humidifier pad (if used).

## Troubleshooting

**Before proceeding, read and understand the safety information contained in the Safety Section of the Wine Guardian Manual**

For in-depth Troubleshooting please head to:

[Help.wineguardian.com](http://Help.wineguardian.com)

### Typical start up problems

Possible Cause	Solution
Loose, improper or defective remote interface controller or humidistat cable	Check power, and remote interface controller or humidistat cable
Incorrect remote interface controller or humidistat (optional) settings	Check the remote interface controller and optional humidistat setup for the application
Changed settings on the remote interface controller	A common problem is not waiting long enough for the internal timers to complete their timed delay

### Unit does not start up

#### **Circuit breaker is on and the remote interface controller light is off**

Possible Cause	Solution
No power to remote interface controller	Check main control board for L.E.D. indication Check wiring for loose, broken or frayed connections Check wiring for proper splicing Remote interface controller may be faulty

#### **Circuit breaker is on and the remote interface controller light is on**

Possible Cause	Solution
Remote interface controller is not set up properly	Check remote interface controller set up in the guide Press fan ON switch to check evaporator fan only

***Unit is operating and blows evaporator air but the supply air is not colder than the return air from the cellar***

Possible Cause	Solution
Remote interface controller not set up properly	Check remote interface controller setup in the manufactures guide
Compressor not operating	High pressure switch open (button up) <i>Alarm will appear on remote interface controller</i>
Condenser airflow is blocked	Remove blockage Clean filter and coil (if needed) Head Pressure (HP) switch is open Reset HP switch <b>See reset instructions on pg. 75</b>

***Cellar temperature too cold (below 51° (10°C) when unit is running***

Possible Cause	Solution
Remote interface controller set too low on cooling	Reset remote interface controller to higher cooling temperature
Heating coil (optional) not operating	Check for remote interface controller rise across coil
Remote interface controller set too low on heating	Reset remote interface controller to higher heating temperature
Remote interface controller not controlling temperature	Remote interface controller mounted in improper location

***Cellar temperature too cold (below 51° (10°C) when unit is not running***

Possible Cause	Solution
Too much heat loss to adjacent spaces	Increase insulation around fan coil Check and clean filter and coil Coil frozen – shut off unit for two hours
Cellar loads are too high	Install additional insulation

***Humidity too low or supply air is too cold, without optional humidifier***

Possible Cause	Solution
Not enough evaporator airflow	Check and clean filter and coil Coil frozen – shut off unit for two hours
Defective thermal expansion valve	If under warranty call for service If not under warranty call a refrigeration Technician
Temperature set too cold	Raise temperature setpoint

<b><u>Humidity Issues</u></b>	
<b><i>Too low, without optional humidifier</i></b>	
<b>Possible Cause</b>	<b>Solution</b>
No moisture being added to cellar	Add Wine Guardian humidifier or a room humidifier

<b><i>Humidity too low, with optional humidifier</i></b>	
<b>Possible Cause</b>	<b>Solution</b>
Humidifier not operating	Check wiring for loose, broken or frayed connections Check humidistat set up Check for water flow and solenoid valve operation
Humidifier operating	Check for water being hot Check drip pad – replace if scaled No vapor barrier around cellar

<b><i>Humidity too high when unit is running but not cooling</i></b>	
<b>Possible Cause</b>	<b>Solution</b>
Compressor not operating	Check and reset high limit switch Clear blockage of condenser airflow
Ambient temperature is too high	Reduce temperature or draw condenser air from another space

<b><i>Humidity too high when unit is not running</i></b>	
<b>Possible Cause</b>	<b>Solution</b>
Unit needs to run to dehumidify	Run unit. Seal openings around doors (gasket and sweep)

<b><i>Humidity too high when unit is running and cooling</i></b>	
<b>Possible Cause</b>	<b>Solution</b>
Too much moisture in cellar	Poor vapor barrier installation Humidifier malfunction refer to the humidifier instructions Add dehumidifier to surrounding space

<b><u>Unit is leaking water</u></b>	
<b>Possible Cause</b>	<b>Solution</b>
Fan-coil sweating	Add insulation around top and sides of fan-coil
Drain line plugged	Clean internal and/or external drain lines
Condensate pan plugged	Remove blockage and clean
Condensate pump not working	Inspect and replace

<b><u>Unit is running properly, but the sound of the unit objectionable</u></b>	
<b>Possible Cause</b>	<b>Solution</b>
Noise is from airflow	Inspect fans for excessive noise. Contact Service Technician
Noise is from unit condensing unit	Identify source of noise. Compressor or fans Contact Service Technician.

### **High Pressure Switch has Shut the Unit Down**

Every Wine Guardian unit has a manual reset high pressure switch in the refrigeration system. This switch shuts the compressor and condenser down if the head pressure in the system is too high. It is intended to protect the compressor. Restricted airflow through the condenser is the most common reason for the pressure becoming too high. This can be caused by dust covering the filter or an obstruction blocking the airflow in the duct or grille.

<b>Possible Cause</b>	<b>Solution</b>
Head pressure in unit is too high because an obstruction is restricting air flow	Remove the obstruction at the condensing unit or clean the condenser coil. Then restart the unit after resetting the using the high pressure switch.

### **Instructions to Reset High Pressure Switch**

1. Remove the side access panel at the condensing unit
2. Locate the high-pressure switch near the compressor
3. Push in the reset button.
4. Re-install top and side access panels

## Advanced Troubleshooting

### **IMPORTANT**

This section is intended for qualified refrigeration service technicians only. The technician should repeat all of the previous troubleshooting steps before taking action on these more technical solutions.

### Evaporator Coil is Freezing

Possible Cause	Solution
Charge too low	Check sight glass Check for leaks Add refrigerant
TXV malfunctioning	Repair or replace

### ***High pressure switch keeps tripping even after checking for obstructions and dirty filters/coils***

Possible Cause	Solution
Condenser fan not operating	Repair or replace
Defective switch	Replace

### Unit cycles on and off more than 8 times/hr

Possible Cause	Solution
Remote interface controller malfunction remote interface controller information	Check the remote interface controller guide for
Low suction pressure	Check low pressure switch Check pressure and adjust superheat

### ***High pitched or loud rubbing noise, clanking or vibration***

Possible Cause	Solution
Fans loose or malfunctioning	Repair or replace
Excessive compressor vibration	Replace
TXV malfunctioning	Repair or replace

### Replacing the blowers

**When replacing the fan or motor, replace the fan and motor as a unit.  
Do not remove the motor from the impeller wheel.**



## Contact and Warranty Information

### Contact Information

**Wine Guardian**  
7000 Performance Drive  
North Syracuse, NY 13212  
Toll free: (800) 825-3268

[help.wineguardian.com](http://help.wineguardian.com)

Normal business hours are 8 a.m. to 5 p.m. Eastern, Monday-Friday.

Web site: [airinnovations.com](http://airinnovations.com)  
Email: [info@airinnovations.com](mailto:info@airinnovations.com)

### Warranty and Warranty Procedure

The Wine Guardian unit serial number is on the serial plate and noted on all packing lists and bills of lading and, along with the shipping date, is kept on file at Wine Guardian for warranty purposes. **All correspondence regarding warranty must include the model number and serial number of the unit involved.** Note that the warranty is null and void if the serial number on the unit or compressor is altered, removed or defaced. All inquires or correspondence regarding warranty should be handled in accordance with the “Warranty” and directed to:

**Wine Guardian**  
7000 Performance Drive  
North Syracuse, New York 13212  
Attn: Service Department  
Toll Free: (800) 825-3268  
Fax (315) 452-7420

This procedure includes but is not limited to:

- Obtaining authorization from Wine Guardian prior to incurring any charges for repair or replacement under warranty.
- Or returning prepaid within 30 days any and all defective parts.

## Warranty

### GENERAL

**Wine Guardian** warrants, to the original buyer, its goods and all parts thereof to be free from defects in material and workmanship for a period of two (2) years from the date of invoicing assuming **NORMAL USE AND SERVICE**.

### LIABILITY

**Wine Guardian** liability shall be limited to the repair or replacement (at its option) of any part, which, at our sole discretion, is determined to be defective. The purchaser shall pay all transportation costs. Additionally, if a malfunction occurs within the first year from the date of invoice, **Wine Guardian** will reimburse the reasonable cost of labor required for the repair or replacement provided authorization is obtained from one of our authorized representatives prior to incurring any labor charges.

### LIMITATIONS OF LIABILITY

THESE WARRANTIES ARE MADE IN LIEU OF ALL OTHER WARRANTIES EXPRESSED OR IMPLIED, INCLUDING ANY IMPLIED WARRANTY OF MERCHANTABILITY OR FITNESS FOR A PARTICULAR PURPOSE AND IN LIEU OF ANY OTHER OBLIGATION OR LIABILITY, INCLUDING LIABILITY FOR ANY INCIDENTAL OR CONSEQUENTIAL DAMAGES. **Wine Guardian** will not be responsible for any costs or liabilities whatsoever resulting from improper installation or service of its equipment. In the event that **Wine Guardian** or its distributors are found liable for damage based on any defect or nonconformity in the products, their total liability for each defective product shall not exceed the purchase price of such defective products. No person or representative is authorized to change these warranties or assume any other obligations or liabilities for **Wine Guardian** in connection with the sale of its systems.

### INDEMNIFICATION

Purchaser agrees to indemnify, hold harmless and defend seller and its officers, directors, agents and employees from and against any and all claims, liabilities, costs and expenses arising out of or related to Purchaser's use of the goods, or in any way involving injury to person or property or accident occasioned by the goods sold by **Wine Guardian** to Purchaser.

### FOREIGN GOVERNMENT AND INDIAN NATIONS

If Purchaser is a foreign government or an Indian nation, Purchaser hereby expressly waives its defense of sovereign immunity in the event of a dispute between Purchaser and **Wine Guardian** regarding this invoice and Purchaser expressly acquiesces to the jurisdiction of the federal and state courts of the United States.

### SEVERABILITY

If one or more of the provisions contained in this contract shall for any reason be held to be invalid, illegal or unenforceable in any respect, such invalidity, illegality or unenforceability shall not affect any provision of this contract, but this contract shall be construed as if such invalid, illegal or unenforceable provision had never been contained.

### ADDITIONAL REQUIREMENTS

If a defect covered by the Warranty occurs, contact Wine Guardian for authorization to proceed with corrective action. Do not return any parts or incur any charges for which you expect to be reimbursed under this Warranty without receiving this authorization. If parts are replaced under this Warranty, the defective parts must be returned prepaid within 30 days. This warranty shall be null and void in its entirety if the Serial Number on the air conditioner or compressor is altered, removed or defaced.