

# ***MINI PLATINUM SPLIT VERSION 4***

## **OWNER'S MANUAL**

**NOTICE:** To activate the split system warranty, the installing certified HVAC/R service tech must complete the split system warranty checklist and send back to WhisperKOOL.

***Whisper*KOOL<sup>®</sup>**  
The Future of KOOL

**Conforms to ANSI/UL Std 427**

**Certified to CAN/CSA Std C22.2 No. 120**

***We manufacture, test and certify 100% of our wine cooling units in the USA. By sourcing the best components and closely controlling our manufacturing processes, we can assure the highest-quality, lowest defect manufacturing rates in the industry.***

Copyright © 2019. WhisperKOOL. All rights reserved.

WhisperKOOL copyrights this manual, the product design, and the design concepts, with all rights reserved. Your rights with regard to the hardware and manual are subject to the restrictions and limitations imposed by the copyright laws of the USA. Under copyright laws, this manual may not be copied, reproduced, translated, transmitted, or reduced to any printed or electronic medium or to any machine-readable form, for any purpose, in whole or in part, without the written consent of WhisperKOOL.

Every effort has been made to ensure that the information in this manual is accurate. WhisperKOOL is not responsible for printing or clerical errors.

WhisperKOOL reserves the right to make corrections or improvements to the information provided and to the related hardware at any time, without notice.

Vinothèque and WhisperKOOL are registered trademarks, and ECE is a trademark of WhisperKOOL. All rights reserved.

Mention of third-party products is for informational purposes only and constitutes neither an endorsement nor a recommendation. WhisperKOOL assumes no liability with regard to the performance or use of these products.

# TABLE OF CONTENTS

<b>Introduction</b> .....	<b>2</b>
<b>Before You Start</b> .....	<b>3</b>
<b>Receiving &amp; Inspecting the System</b> .....	<b>4</b>
<b>Quick Reference Guide</b>	
System.....	5
Display Layout & Unit Specifications .....	6
<b>Preparing the Wine Cellar</b> .....	<b>7</b>
<b>Liquid-Measuring Thermostat (Bottle Probe)</b> .....	<b>10</b>
<b>System Operation</b> .....	<b>11</b>
<b>Controller Functions</b> .....	<b>13</b>
<b>WhisperKOOL Troubleshooting Guide</b> .....	<b>19</b>
<b>Maintenance Schedule</b> .....	<b>21</b>
<b>Technical Assistance &amp; Accessories</b> .....	<b>22</b>
<b>Installation Terms &amp; Conditions</b> .....	<b>23</b>

## **INTRODUCTION**

### **Customer Service**

Thank you for purchasing a WhisperKOOL cooling system. We strive to provide the highest-quality products and the best possible customer service. If you have any questions about your system, please call us at 1-800-343-9463 or visit [WhisperKOOL.com](http://WhisperKOOL.com).

### **Using the Manual**

This manual is intended to assist in the proper maintenance of the cooling system. In order to ensure the longevity of your cooling unit, the equipment should be installed as outlined in the technician's manual. It is also vital to establish a proper care and maintenance schedule. Please read and review this manual carefully and keep it for future reference.

### **What is the WhisperKOOL Cooling System?**

The WhisperKOOL cooling system is a specialized refrigeration system designed for one purpose only: to maintain the optimal temperature and humidity levels conducive to the proper storage and aging of fine wines. This system produces minimal in-cellar noise and has the most lenient exhaust requirements. An exterior housing is required for outdoor condensing unit installations.

### **How Does the Cooling System Work?**

Similar to the air conditioning systems used for homes, the evaporator unit (fan coil unit) and condensing units are installed in separate locations and are connected by a refrigerant line set. The evaporator portion is commonly installed in the wine cellar, with the condensing unit is located either outside or in a remote indoor location that is ventilated. An exterior housing is required for outdoor condensing unit installations.

### **Temperature Setting**

The system is designed to maintain a cellar temperature of 55°F as long as the ambient temperature does not exceed 110°F.

## **WARRANTY REGISTRATION**

In order to activate the warranty of your system, the verification and operational documentation must be completed by the certified refrigeration technician installing your system and submitted via mail, fax, or e-mail.

Mail to:  
WhisperKOOL  
ATTN: Warranty Registration  
1738 E. Alpine Avenue  
Stockton, CA 95205-2505  
USA

Fax to:  
209-466-4606

Scan and email to:  
[warranty@whisperkool.com](mailto:warranty@whisperkool.com)

**BEFORE YOU START****1-800-343-9463**

1. **Inspect all components prior to installation.** If damage is found, please contact your distributor or WhisperKOOL Customer Service at 1-800-343-9463.
2. The evaporator unit and condensing unit **each require a dedicated 115V, 15-amp circuit.** Use a surge protector with the unit. **Do not use a GFI** (ground fault interrupter) line.
3. The evaporator unit and condensing unit require no communication lines.
4. You are **REQUIRED** to **install a drain line** to remove condensation from the evaporator unit (fan coil unit).
5. ***The warranty is not active until a warranty checklist has been received, reviewed, and approved.***
6. The system is intended **for use in properly designed and constructed wine cellars.** Hire a professional wine storage consultant with a valid contractor's license to build your wine cellar.
7. WhisperKOOL requires that all split systems be installed by a certified HVAC-R technician only. NATE or equivalent is recommended.

If you encounter a problem with your WhisperKOOL system, please refer to the Troubleshooting Guide. If you have any further questions or concerns, or need assistance, please contact WhisperKOOL's Customer Service at 1-800-343-9463. Please be sure all testing has been completed prior to contacting Customer Service. Please have your results ready for your representative.

## RECEIVING & INSPECTING THE SYSTEM

### Upon receiving your WhisperKOOL unit:

- Use caution when lifting and check package for damage.
- Lift only at the designated hand-hold locations on the shipping container, or fully support the unit from underneath. A shipment may include one or more boxes containing accessories.
- Before opening the container, inspect the packaging for any obvious signs of damage or mishandling.
- Write any discrepancy or visual damage on the bill of lading before signing.
- Allow the condensing unit to sit for 24 hours prior to start-up. The condensing unit can be placed in the installation location, piped and evacuated during this time.

**Note:** WhisperKOOL units are manufactured in the USA and tested prior to shipment.

- Review the packing slip to verify contents
- Check the model number to ensure it is correct.
- Check that all factory options ordered are listed.

**If any items listed on the packing slip do not match your order information, contact WhisperKOOL Customer Service immediately.**

### Check all shipped boxes for the following contents:

#### Evaporator Unit Box:

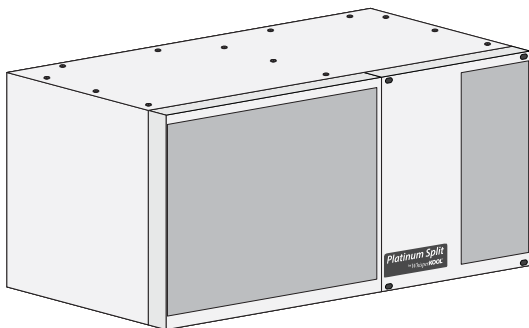

(1) Platinum Mini Split evaporator unit

#### Condensing Unit Box:



(1) Condensing unit

#### Documentation bag:

- Mini Split Version 3 owner's manual
- Mini Split Version 3 technician's manual
- R-134a split system warranty checklist
- Mini Split evaporator unit installation template

#### Accessory kit bag:

- Retractable bottle probe
- KDT Plus display cable (50 feet)
- KDT Plus wall mount bracket assembly
- KDT Plus flush mount bracket assembly
- KDT Plus display assembly
- Flush mount template
- Evaporator installation hardware bag
- KDT Plus hardware bag

#### Evaporator installation hardware bag:

- (2) 1/2" x 1/2" nylon barbed fitting
- (1) 1/2" barbed tee
- (1) Double-D strain relief
- (4) 3/4" adhesive cable tie mounts
- (2) Small cable ties
- (4) #8 x 1 3/4" hex-head screws

#### KDT Plus hardware bag:

- (1) 1/16" OD grommet
- (2) 1/2" nylon hole plug
- (4) #6 x 1" Phillips zinc Type A screw
- (4) 8-10 x 7/8" blue plastic screw anchor
- (1) Small black strain relief bushing

#### Condensing unit accessory kit:

- (1) Filter drier
- (1) Sight glass

Please leave the unit in its original box until you are ready for installation. This will allow you to move the product safely without damaging it. When you are ready to remove the product from the box, refer to the installation instructions.

**TIP:** Save your box and all packaging materials. They provide the only safe means of transporting/shipping the unit.

# QUICK REFERENCE GUIDE

## Front / Side View

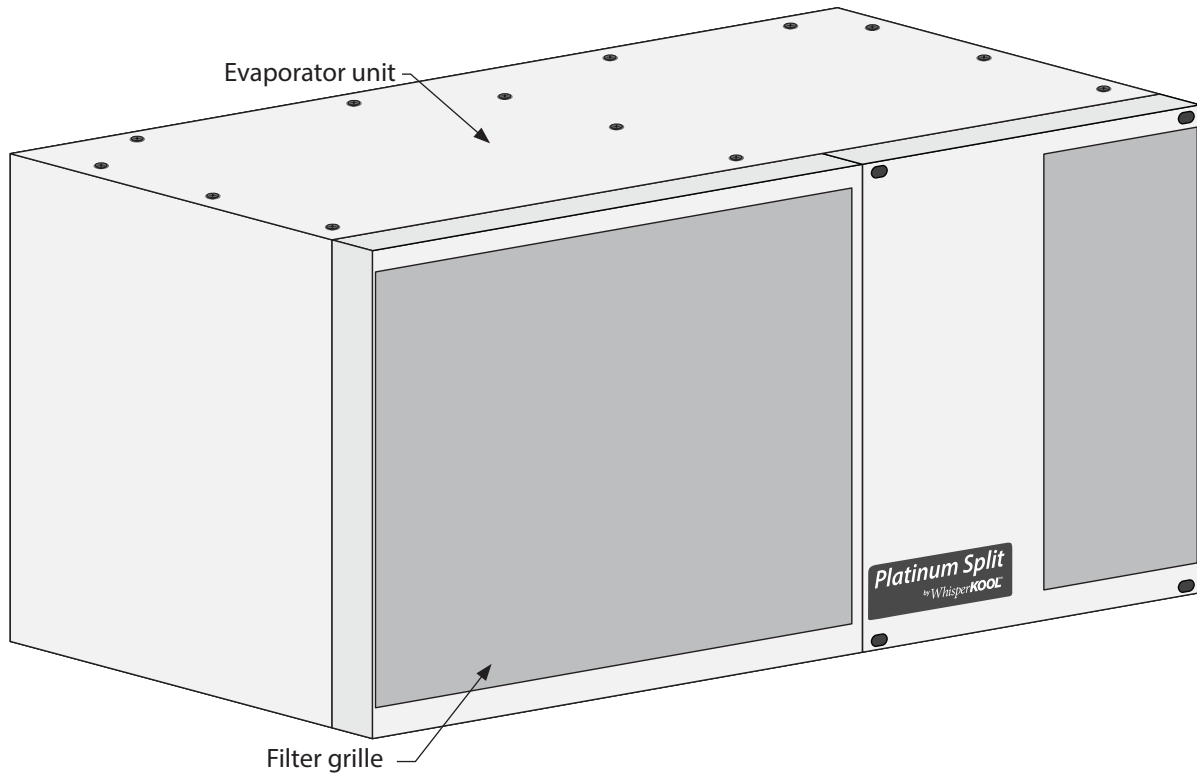

## Rear / Side View

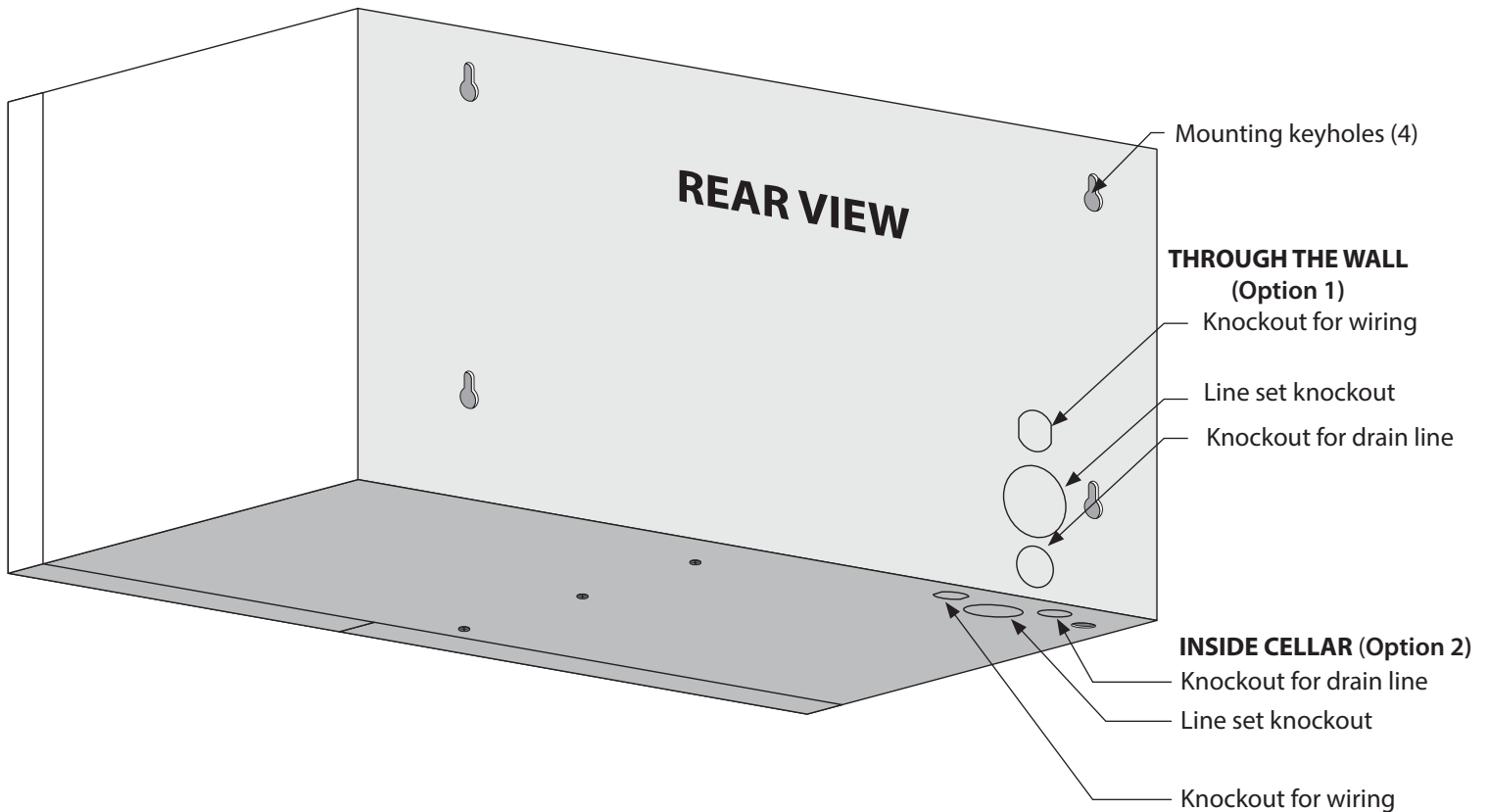

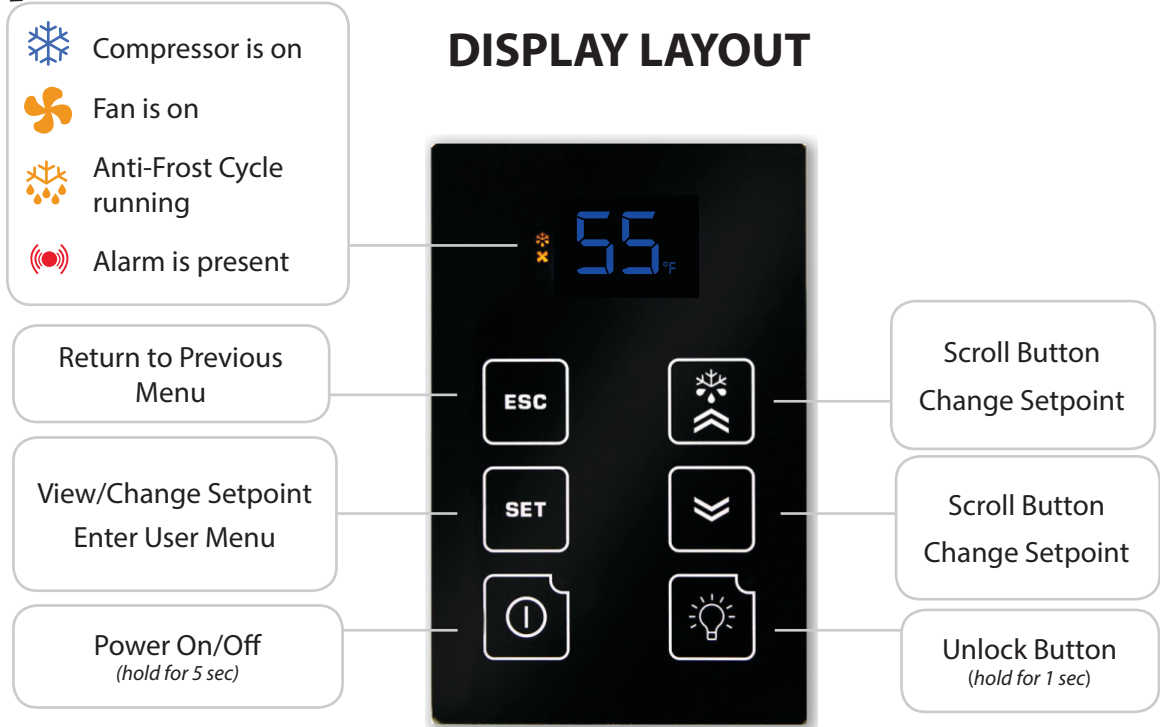

## PLATINUM MINI SPECIFICATIONS

Model	Mini Evaporator Unit (Fan Coil Unit)	Mini Condenser (Air-Cooled Condensing Unit)
Cellar Size	500 cu. ft.* (when cellar is fully insulated and sealed with a proper vapor barrier)	
BTU/h w/85°F air entering condenser coil	2101	
Dimensions	13"L x 20"W x 10.5"H	13.97"L x 15.85"W x 9.86"H
Refrigerant	R-134a	
Condensing Unit HP	1/6	
Voltage Rating	115V (15-amp dedicated circuit required)	
Weight (lbs)	50	50
Amps	Evaporator: 1 running amp Compressor: LRA 26, RLA 4.4	
Line Set	Liquid line ¼" OD; suction line ⅜" OD (less than 50 ft.), ½" (greater than 50 ft.)	
Drain Line	½" ID clear plastic tubing (not included)	
Installation	Evaporator unit is installed in the cellar. The condensing unit is installed up to 100 line feet from evaporator unit.	
Thermostat	Advanced digital display (50-ft. cable), liquid-temperature-measuring bottle probe	
Temp. Delta	Can maintain a 55°F cellar temperature with up to 110°F condenser air intake temperature	
Warranty	Two-year limited warranty (parts and labor)	

\*Each wine cellar is unique and has specific cooling requirements. Heat load calculations should always be performed prior to selecting a cooling unit.)



## PREPARING THE WINE CELLAR

The performance and life of your system is contingent upon the steps you take in preparing the wine cellar. Improperly preparing your enclosure or incorrectly installing your unit may cause unit failure, leaking of condensation, and other negative side effects.

**It is highly recommended that you obtain the assistance of a wine storage professional.**

Wine storage professionals work with licensed contractors, refrigeration technicians, and racking companies to build well-insulated, beautiful, and protective wine cellars. WhisperKOOL has put together some useful tips to assist in the installation process. Our recommendations are meant to act as a guide in the process of building a proper enclosure. Your intended location may have specific needs which we do not address.

### Wall & Ceiling Framing

Build wine cellar walls using standard 2x4 or 2x6 boards and ceiling joists without violating local or state codes in your area. As a general rule, the thicker the walls and the higher the insulation value, the more consistent your cellar temperature will be.

### Insulation

Insulation is **REQUIRED** in order to properly use WhisperKOOL products. It is vital that all walls and ceilings be insulated to keep the cellar temperature as consistent as possible during the summer and winter months. Standard fiberglass or rigid foam insulation is normally used in cellar construction; in some cases, "blown-in" insulation is used. The R-value, or quality of insulation, is determined by the rate at which heat passes through the insulation. The higher the R-value, the more resistant the insulation is to conducting heat, and the more consistent your wine cellar's temperature will be. Using higher R-values in insulation will lower your operating costs and WhisperKOOL unit run time. (R-13 is the recommended minimum; R-19 is preferred for interior cellar walls, and R-30 for ceilings and exterior walls.)

### Vapor Barrier

Water vapor creates its own pressure, separate from the ambient air pressure, and will intrude into colder/drier areas. A vapor barrier is **REQUIRED** in order to prevent the intrusion of water vapor and maintain the correct cellar temperature and humidity. It is recommended that 6-millimeter plastic sheeting be applied to the warm side of the cellar walls. The vapor barrier must also be applied to the outside walls and ceiling. If it is impossible to reach the outside, then the plastic must be applied from within the cellar. The most common method is to wrap the entire interior, leaving the plastic loose in the stud cavity so the insulation can be placed between each stud. All of the walls and ceiling must be wrapped in plastic for a complete vapor barrier.

In areas of high humidity, such as Southern and Gulf States, the vapor barrier will prevent infiltration of warm moist air. The moist air can cause mold to form, and standing water in drain pans promote microbial and fungal growth that cause unpleasant odors and indoor air quality problems. If mold is found, remove it immediately and sanitize that portion of the unit.

**Note:** High humidity significantly increases the heat load on the cooling system.

Any break in the vapor barriers (cut, nail hole, over-lapping, etc.) will cause a moisture leak and must be sealed. The electric conduit is a "duct" for vapor to travel in. The conduit should be caulked and sealed on the warm air end.

## Mounting the Evaporator Unit

The evaporator unit must be mounted within 18" of the top of the room in order to achieve sufficient cooling. As the room cools down, the warm air will rise to the ceiling. Mounting the unit high in the room will create a consistently cool environment by capturing the warm air and replacing it with cool air. Mounting the unit low in the room will result in a temperature variation in the room due to the unit's inability to draw warm air from the ceiling of the cellar to the unit itself, and cold air settling to the floor.

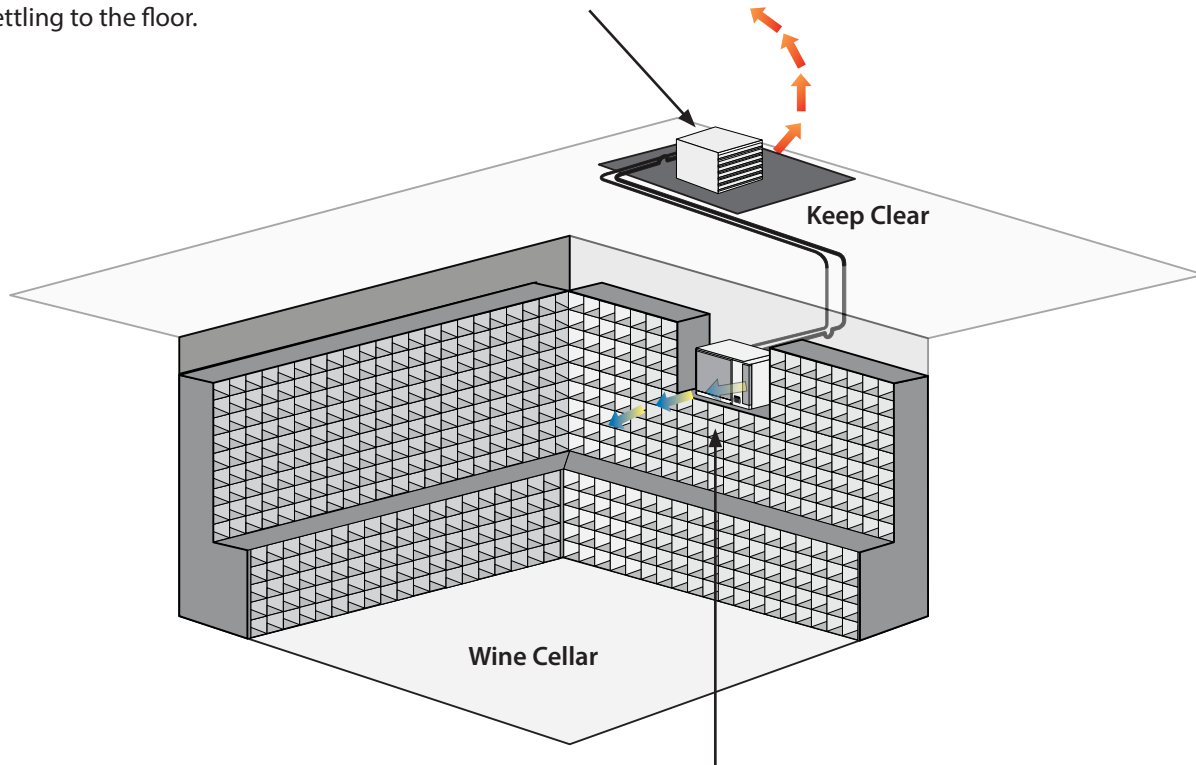

### Unobstructed Airflow

Unobstructed airflow to and from the system is critical for the evaporator unit and condensing units overall performance and lifespan. A minimum of 3 feet of clearance (5 feet is ideal) on all sides is crucial. The air the fans blow needs to circulate and either dissipate or absorb heat from the space. The more air to exchange, the more efficient the system will operate.

**Note:** Avoid attempting to camouflage the unit. This will restrict airflow and thus the systems ability to work efficiently.

## Door and Door Seal

An exterior grade (1 $\frac{3}{4}$ " ) door must be installed as a cellar door. It is essential that weather stripping is attached to all 4 sides of the doorjamb. A bottom "sweep" or threshold is also required. The door must have a very good vapor seal to prevent warmer moist air from leaking into the cellar. One of the most common problems with cooling systems running continually is due to the door not sealing properly. **In cases where glass doors are used and the room size is close to the recommended system size, the next larger size WhisperKOOL system should be used.** This will compensate for the insulation loss due to the lower insulating rating of glass.

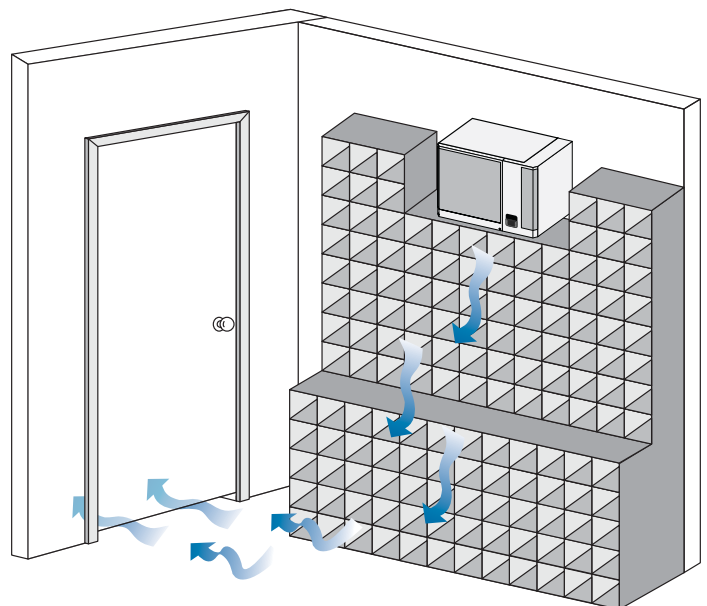

## Ventilation

The necessity of dissipating heat away from the condensing unit is critical to the unit's performance and cannot be overstated. As the system operates and cools, a greater amount of heat is generated on the condensing side of the system. Adequate ventilation is required in order to dissipate heat away from the condensing unit. If ventilation is inadequate, the exhaust will heat up the area or room and adversely affect the system's ability to cool. In some cases, it may be advisable to install a vent fan to dissipate heat within the exhaust area on the condensing side of the system. However, you must have a fresh air inlet as well.

**Note:** If you are unsure about having adequate ventilation in your install location, please contact us to assess your specific installation at [support@whisperkool.com](mailto:support@whisperkool.com) or 1-800-343-9463.

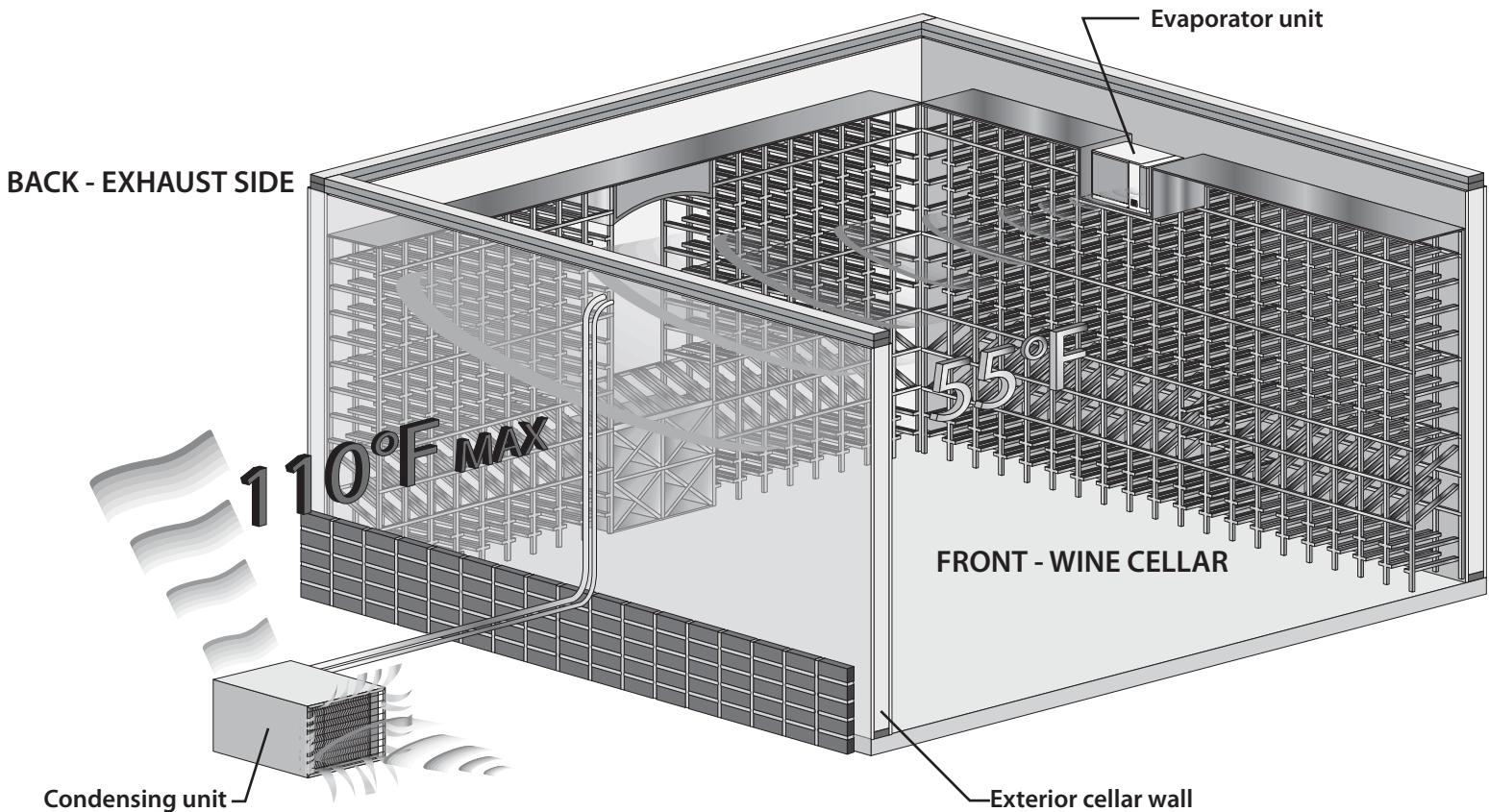

## Ambient Temperature Factor

The cooling system has the ability to cool a wine cellar efficiently to 55°F as long as the ambient temperature of the area that it is exhausting to does not exceed 110°F. Therefore, you want to exhaust the condensing unit in a space which will not exceed 110°F. Otherwise the system will not have the capacity to keep the wine at a desirable 55°F.



**WARNING! Allowing your system to operate in high ambient temperatures for extended periods of time will greatly decrease the life of your system and void your warranty. The cooler the temperature of the air entering the condenser coil, the more cooling capacity the system has. The less heat gain through the common wall, the less the electricity consumption.**



## LIQUID-MEASURING THERMOSTAT SYSTEM (BOTTLE PROBE)

WhisperKOOL cooling units come with a liquid-temperature-measuring thermostat. The self-calibrating probe contains a sensor chip, which communicates back and forth with the thermostat. This results in a consistent temperature setting and accuracy. Wine should be kept at a very precise, controlled temperature and humidity. By measuring the liquid temperature rather than air, the unit will operate 75–80% of the time.

### Setting up the Bottle Probe:

1. Locate an empty wine bottle.
2. Fill it 75% full with room-temperature tap water.
3. Place bottle probe securely into bottle as seen in Figure 1.
4. Place the wine bottle in your wine cellar. Ensure sensor tip is fully submerged.
5. To ensure a consistent temperature, place bottle probe approximately three (3) feet away from the air output and not in the flow of the air.

**It is recommended that the bottle be placed in a central location of your wine cellar.** Avoid pulling too much on the probe cord. It may become disconnected resulting in limited functionality of the unit.

**Note:** The thermostat can be set between 50–70°F.

**Remember:** The unit operates based on the temperature of the water. Do not be misled by thermostats reading air temperature. The air temperature in the cellar will be cooler than the liquid temperature of the wine while it is reaching the optimum balanced temperature.

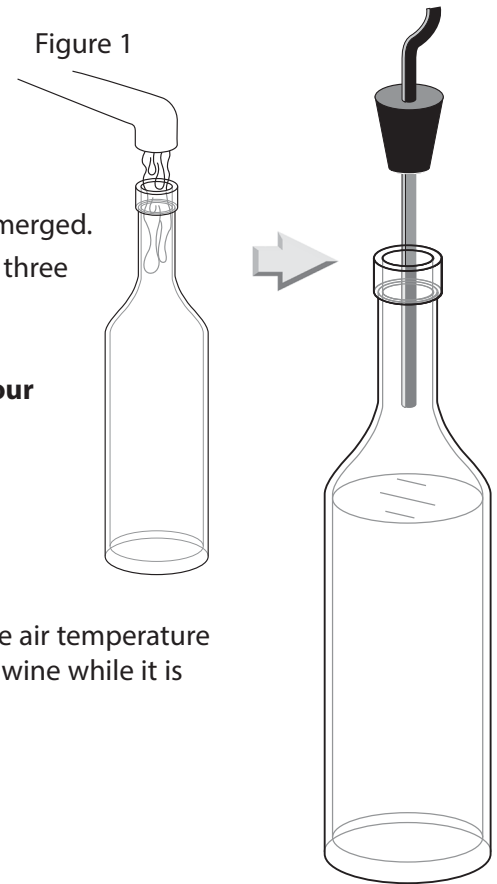

## SYSTEM OPERATION

### Initial Start-Up

When the unit is plugged in and power is sent to the controller, a beep will sound, confirming that the controller is getting power. All LEDs on the display will blink three times. Three dashes will then appear on the screen. All display LEDs will then blink three times. Once the controller has gone through the initial startup process, and all LEDs have cycled, the home screen will be displayed.

### Setpoint

The setpoint is preset at the factory to 55°F. It can be adjusted by the customer between 50–70°F in one-degree increments.

### Indoor Fan Operation

The indoor fan will run when the controller is calling for cooling and turn off once the cooling cycle has ended. During the cooling cycle, the system will remove some relative humidity from the cellar. Some of the humidity that was removed can be reintroduced into the cellar by adjusting the “fan on” and “fan off” functions. (The cooling system is not equipped with a humidifier and does not add humidity.)

The FOF cycle should be shortened first. This will reduce the amount of time that the fan remains off following a cooling cycle. When the unit has completed a cooling cycle, the compressor and the condenser fan will turn off, but the indoor fan will continue to run for whatever length of time the customer has set. The Fon function may then be lengthened to allow the fan to run longer and reintroduce moisture from the evaporator coil back into the wine cellar.

For more information about fan settings, refer to the User Menu on page 16.

### Anti-Short Cycle

The Anti-Short Cycle ensures that the unit will remain off for a period of five minutes after the unit has reached the setpoint. This allows the pressure in the refrigeration system to equalize prior to starting the compressor.

Once the solenoid relay is de-energized, the controller must wait five minutes before reenergizing the relay. This prevents the compressor from repeatedly turning off and on. If the unit is calling for cooling during this time, the compressor icon will blink, indicating that cooling is needed but the controller is waiting for the Anti-Short Cycle delay.

### Anti-Frost Cycle

When the evaporator probe senses a temperature of 26°F for a duration of one minute, an Anti-Frost Cycle will be initiated. This will shut down the compressor, allowing the evaporator fan to run and melt any frost accumulation on the coil. While the Anti-Frost Cycle is running, “dEF” will be displayed on the screen.

The compressor will remain off until the evaporator coil reaches 40°F, or for a maximum of one hour. The unit will then return to normal operation.

### Operation in Low Ambient Temperatures

The condensing unit comes equipped with a LAC (Low Ambient Control). The LAC is a three-way modulating valve that responds to discharge pressure. When the discharge pressure falls below the valve’s dome pressure, the valve modulates open to the discharge port which allows discharge gas to bypass the condenser. Mixing the discharge gas with the liquid creates high pressure at the condenser outlet, reducing the flow and causing liquid to backup in the condenser. Flooding the condenser reduces the area available for condensing. This reduction in condenser surface area results in a rise in condensing pressure during cold ambient conditions.

The condensing unit controller is preset at the factory. The cut-in pressure is preset to 25psi and the cut-out pressure at 15psi. During low ambient temperatures (40°F or below), it will be necessary to adjust the cut-in pressure to 10-15psi (15psi is preferred) and the cut-out to 5psi to ensure compressor startup. See page 17 for instructions on adjusting the cut-in and cut-out pressures of the condensing unit.

### Digital Display

The display is designed to give the user the ability to adjust the setpoint, Fon/FOF parameters, and other settings. (See User Menu on page 16 for more details.) The bottle probe temperature is displayed by default. “dEF” will be displayed during an Anti-Frost Cycle. The bottle probe and evaporator probe temperatures can be accessed by pushing the SET button and scrolling through “Pb1” (bottle probe) and “Pb2” (evaporator probe). The light button may be used as an unlock button.

### Safety Features

In the event of a faulty bottle probe, the compressor will cycle off for 10 minutes and on for 40 minutes. “E1” will be displayed on the screen.

### Alarms

See “Alarm Codes” in the Controller Functions chart.



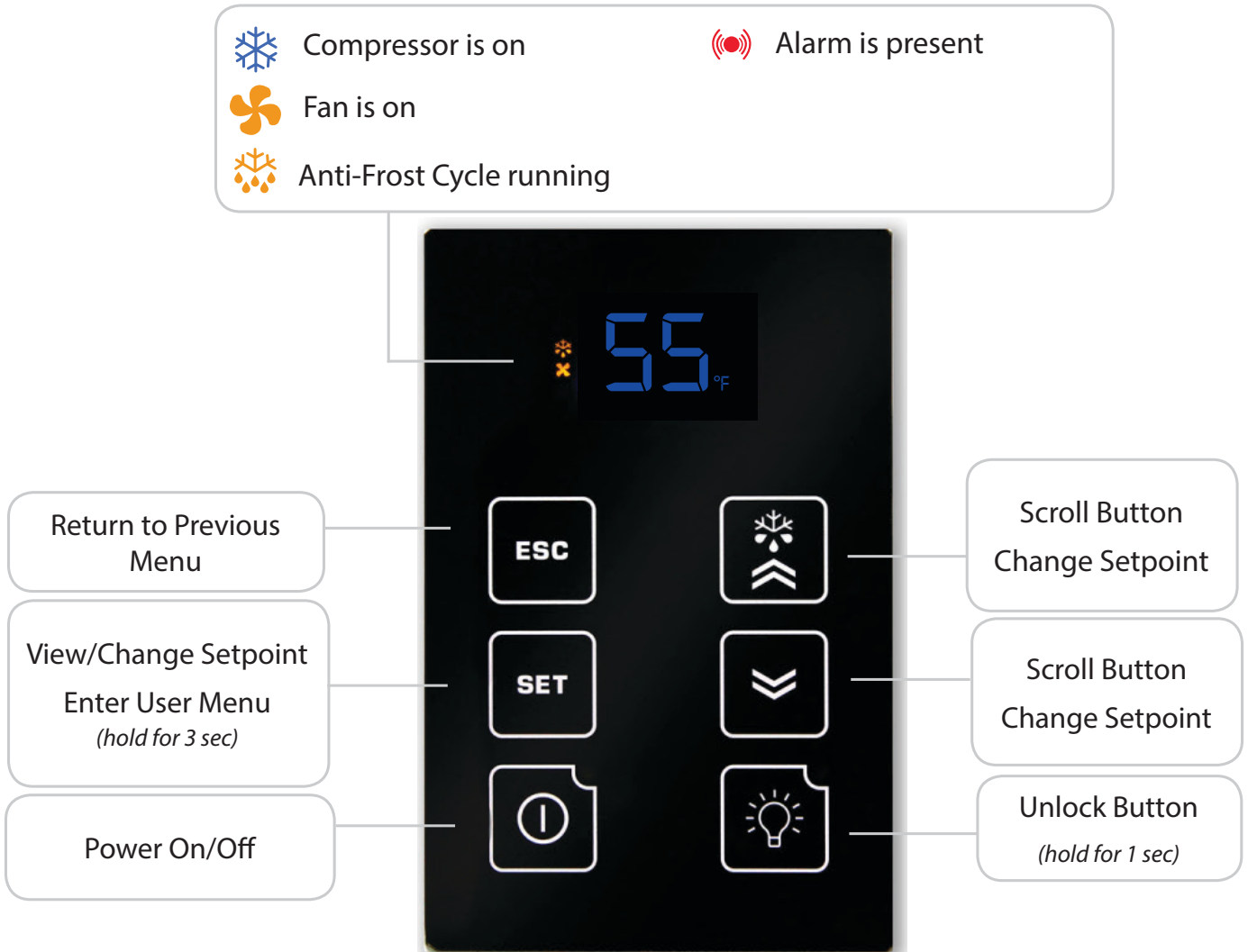

**DISPLAY LAYOUT\***







\* The display can be mounted on any wall (inside or outside the wine cellar), up to 50 feet from the cooling unit.



## WHISPERKOOL CONTROLLER FUNCTIONS



Button	Normal Functions								
<b>INITIAL STARTUP</b>	When the unit is plugged in and power is sent to the controller, a beep will sound, confirming that the controller is getting power. All LEDs on the display will blink three times. Three dashes will then appear on the screen. All display LEDs will then blink three times. Once the controller has gone through the initial startup process, and all LEDs have cycled, the home screen will be displayed.								
<b>UNLOCKING THE DISPLAY</b>	Press and hold any button for one second to unlock the display. (A white LED will appear in the top left corner of the button being pressed.) A beep will sound, signifying that the display is unlocked. <b>NOTE:</b> The display must be unlocked before any button functions become available.								
<b>ON/OFF</b> 	To turn the unit ON, press and hold the ON/OFF button until the red LED turns OFF.  To turn the unit OFF, press and hold the ON/OFF button until the red LED turns ON.								
<b>UP/DOWN</b> 	The up and down arrows are used to navigate through menus and adjust parameters such as setpoint, Fon/FOF, etc.								
<b>SET</b> 	<ul style="list-style-type: none"> <li>To change the setpoint, press the SET button. When "SET" is displayed on the screen, press the SET button once more. Use the UP and DOWN ARROW buttons in order to change the value until the desired setpoint is reached.</li> <li>The SET button allows you to view the setpoint, evaporator temperature, bottle temperature, alarms, and the hidden menu.</li> <li>Press the SET button once. "SET" will be displayed. Press the UP or DOWN ARROW buttons to scroll through ALr, Pb1, or Pb2.</li> </ul> <table border="1"> <thead> <tr> <th>Set</th> <th>Setpoint</th> </tr> </thead> <tbody> <tr> <td><b>ALr</b></td> <td>Alarm folder</td> </tr> <tr> <td><b>Pb1</b></td> <td>Liquid (bottle probe) temperature</td> </tr> <tr> <td><b>Pb2</b></td> <td>Evaporator coil temperature</td> </tr> </tbody> </table> <ul style="list-style-type: none"> <li>Press the SET button again to view any of these values.</li> <li>Hold the SET button for approximately 5 seconds to enter the User Menu. (More information about the User Menu is available on page 16.)</li> <li>Other parameters in the User Menu which are not available for adjustment include: idF, rEL, and LAN.</li> </ul>	Set	Setpoint	<b>ALr</b>	Alarm folder	<b>Pb1</b>	Liquid (bottle probe) temperature	<b>Pb2</b>	Evaporator coil temperature
Set	Setpoint								
<b>ALr</b>	Alarm folder								
<b>Pb1</b>	Liquid (bottle probe) temperature								
<b>Pb2</b>	Evaporator coil temperature								
<b>ESC</b> 	This button confirms changes made to parameters such as the setpoint and returns you to the previous menu.								
<b>LIGHT</b> 	The light function is not in use. However, this button can still be used to unlock the display.								

## ICON GLOSSARY

Icon	Meaning
<p><b>SNOWFLAKE</b></p> 	<p><b>Blinking:</b> The unit is calling for cooling, but must wait five minutes before restarting the compressor. This five-minute delay serves as an Anti-Short Cycle for the compressor's protection.</p> <p><b>Constant:</b> The unit is in cooling mode and the condensing unit is running.</p>
<p><b>DRIPPING SNOWFLAKE</b></p> 	<p>The unit is undergoing an Anti-Frost Cycle. While the Anti-Frost Cycle is running, "dEF" will be displayed on the screen. See System Operation page for further details.</p>
<p><b>FAN</b></p> 	<p>The evaporator fan is running.</p>
<p><b>ALARM</b></p> 	<p>The alarm icon is shown when the unit encounters an issue that needs attention. Alarm codes are explained on the following page. All temperature-related alarms are blocked for the first 10 hours after the unit is plugged in to allow the system to stabilize and acclimate to the new environment.</p>



## ALARM CODES

Code	Cause	Solution
<b>The following alarm codes will be displayed on the screen along with the alarm icon. </b>		
<b>E1</b>	Bottle probe is not connected	Attach bottle probe to circular connector
	Faulty bottle probe connection	Locate faulty bottle probe connection by inspecting all wiring connections between the bottle probe and the circuit board. The two-pin connector for the bottle probe should be connected to the CPB/PB1 terminal on the circuit board. If it is not connected, plug it in. If a faulty connection has been identified, correct the issue or contact customer service for further assistance.  <b>NOTE:</b> The E1 code will not appear in the alarms menu. It will be permanently displayed on the screen.
	Defective bottle probe	Replace the bottle probe
<b>E2</b>	Faulty evaporator probe connection	Locate faulty evaporator probe connection by inspecting evaporator probe wire. The two-pin connector for the evaporator probe should be connected to the CPB/PB2 terminal on the circuit board. If it is not connected, plug it in.
	Defective evaporator probe	Replace the evaporator probe
<b>E7</b>	No communication between keypad and circuit board for 60 seconds	Verify that the display cable is connected to the keypad and the circuit board and is not damaged, frayed, or kinked. If problem persists, contact Customer Service for troubleshooting information.
<b>E10</b>	Clock battery is dead	Replace battery  <b>NOTE:</b> A dead clock battery will not affect the operation of your cooling unit.
<b>The following alarm codes will not be displayed on the home screen. However, the alarm icon will be displayed in the event of an alarm. The alarms can be viewed in the Set Menu's ALr folder. </b>		
<b>EA</b>	Unit is not draining properly	<ol style="list-style-type: none"> <li>1. Check to see that the unit is level; if not, level it</li> <li>2. Verify that the drain line is not clogged; if so, clear obstruction</li> <li>3. Ensure that the condensate pump is operating</li> <li>4. Verify wire connection at D.I. port of circuit board</li> </ol> <b>NOTE:</b> If the drain line is obstructed or the pump fails for some reason, and the water level in the drip tray gets too high, the unit will not operate until the water in the internal drip tray drops back below the proper level.
<b>AH1</b>	The bottle probe is sensing a temperature that is 8°F above the setpoint	<ol style="list-style-type: none"> <li>1. Allow time for the wine to reach the desired temperature</li> <li>2. Ensure that the cellar is sealed properly</li> <li>3. Verify that the bottle probe is calibrated correctly (refer to the User Menu on the following page)</li> <li>4. Verify that the unit is sized correctly for the cellar</li> </ol>
<b>AL1</b>	The bottle probe is sensing a temperature that is 8°F below the setpoint	<ol style="list-style-type: none"> <li>1. Make sure the unit is not in cooling mode (the snowflake icon will not be illuminated)</li> <li>2. Add heat to the room until the wine reaches the desired temp</li> <li>3. Verify that the bottle probe is calibrated correctly (refer to the User Menu on the following page)</li> </ol>
<b>Ad2</b>	The Anti-Frost Cycle ended on time-out	<ol style="list-style-type: none"> <li>1. Check the evaporator coil for ice buildup. Unplug the unit and allow the coil to thaw before restarting.</li> <li>2. Make sure the room to which the unit is exhausting is not below 60°F</li> <li>3. If the unit repeatedly goes into Anti-Frost Cycles (one per minute), call Customer Service for more troubleshooting information</li> </ol>

## USER MENU

The User Menu is accessed by **pressing and holding the SET button for 3 seconds**. Use the UP and DOWN ARROW buttons to navigate to desired parameters. Press the SET button again to view these parameters. Press the UP and DOWN ARROW buttons to adjust a parameter.

The following parameters are available in the menu:

Parameter	Description
<b>Fdc - humidity enhancement</b>	This parameter is measured in minutes, and is preset at the factory to 1. An increase in this parameter will increase the humidity enhancement of your cellar. This parameter should not be adjusted to zero. Adjustments should be made in increments of 5, with a maximum of 15 and a minimum of 1. After making any adjustments to humidity enhancement, <b>you should wait a minimum of 3 days</b> before making any additional adjustments. This will allow sufficient time for the cellar to acclimate to the new setting.
<b>FOF - "fan off"</b>	This setting controls how long the fan stays off after the setpoint has been reached. It is preset to 15 minutes. This setting should not be adjusted, as most properly constructed wine cellars retain an ample amount of humidity during the "fan off" cycle. If, however, you wish to decrease the duration of the "fan off" cycle (in order to increase the wine cellar's relative humidity), you can adjust this setting in the User Menu.
<b>Fon - "fan on"</b>	The "fan on" time is preset to zero minutes. This keeps the relative humidity of the wine cellar at a stable level. If, however, you wish to raise the relative humidity of your wine cellar, you can increase the duration of the "fan on" cycle in increments of five (5, 10, or 15 minutes). After making any adjustment to the "fan on" cycle, <b>you should wait a minimum of 3 days</b> before making any additional adjustments. This will allow sufficient time for the cellar to acclimate to the new setting.
<b>CA1 - bottle probe (Pb1) calibration</b>	<b>CA1 - bottle probe (Pb1) calibration:</b> You may use this parameter to calibrate the bottle probe to a known temperature. This parameter can be adjusted between -12°F and 12°F. For example, if the bottle probe temperature is 58°F, and the known temperature is 55°F, you can set the CA1 parameter to -3°F to match the known temperature.
<b>PA2 - installer menu</b>	This menu is only accessible using a password and is not available for adjustment.
<b>dOA - digital input</b>	This setting determines which of the unit's components will be activated or deactivated when a certain electrical relay is activated or deactivated in response to an alarm. The controller comes pre-programmed with a factory setting of 2.  2 = activates the compressor and fans 5 = disables the compressor and fans  <b>NOTE:</b> Setting the dOA to any number other than 2 or 5 will prevent the unit from operating properly.

# Emerson™ Electronic Unit Controller

## Quick setup and troubleshooting guide

### Adjusting Low Pressure Settings

- Hold DOWN and SET simultaneously for 3 seconds to enter menu (PSI light will flash) ▼ + SET
- Cycle through menu options – UP/DOWN ▲ ▼
- Select function – SET SET
- Adjust value – UP/DOWN ▲ ▼
- Store function - SET SET
- Exit menu - UP and SET ▲ + SET



Low Pressure Cut-In



Low Pressure Cut-Out

### Accessing Alarm Code Information

- Press and release ALARM 📖
- Cycle through menu options – UP/DOWN ▲ ▼
- Press SET to see number of alarms SET
- Press SET again to return to menu options SET
- Exit menu - UP and SET ▲ + SET

Alarm	Description
PoF	Keypad locked
Pon	Keypad unlocked
P1	Suction probe failure
P2	Condenser probe failure
P3	DLT probe failure
HA	High condenser temperature alarm
dLt	DLT temperature alarm
dLL	DLT lock alarm
HP	High pressure trip alarm
HPL	High pressure trip lock-out alarm
EE	Module Failure
LOC	Number of lock-outs

Note: After 15 seconds of inactivity the controller will revert to the default display.

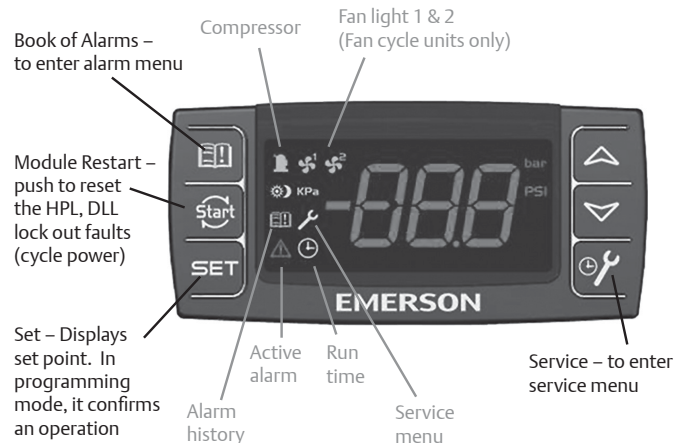

When light is on, feature or component is on or active

### Accessing Service Menu

- Hold SERVICE for 3 seconds 🔧
- Cycle through menu options – UP/DOWN ▲ ▼
- Press SET to see number of alarms SET
- Press SET again to return to menu options SET
- Exit menu - UP and SET ▲ + SET

Code	Description
StH	CompressorStarts -1000 -999999
StL	Compressor Starts -0 -999
CHH	CompressorHours -1000 -999999
CHL	Compressor Hours -0 -999
F1H	Fan 1 Hours -1000 -999999
F1L	Fan 1 Hours-0 -999
F2H	Fan 2 Hours -1000 -999999
F2L	Fan 2 Hours -0 -999

Example: If StH=12 and StL=500, the total number of compressor starts=12,500

For more information visit [EmersonClimate.com/ElectronicUnitController](http://EmersonClimate.com/ElectronicUnitController) or call 1-888-367-9950



Display	Likely Causes	Other Possible Causes
Controller display remains blank after applying power	<ul style="list-style-type: none"> <li>Unit power not properly applied - check for proper applied voltage</li> <li>Power cable harness not plugged in properly or securely into the back of the controller – check connections</li> </ul>	<ul style="list-style-type: none"> <li>Power cable miswired – inspect cable, replace if needed</li> <li>Electrical assembly miswired – trace wiring diagrams</li> </ul>
Controller displays correctly, but the green compressor light is off and the compressor is not running	<ul style="list-style-type: none"> <li>Jumper cable not plugged in properly or securely into the back of the controller – check connections</li> <li>Controller is currently above the cut-in setting – check cut-in and cut-out settings</li> </ul>	<ul style="list-style-type: none"> <li>Jumper cable miswired – inspect cable, replace if needed</li> </ul>
Controller displays correctly and the green compressor light is on and the compressor is not running	<ul style="list-style-type: none"> <li>Power cable harness not plugged in properly or securely into the back of the controller – check connections</li> </ul>	<ul style="list-style-type: none"> <li>Power cable not wired to the contactor or compressor correctly, check wiring</li> <li>Power cable miswired – inspect cable, replace if needed</li> </ul>
Controller flashes “135” or “P1”	<ul style="list-style-type: none"> <li>Current system pressure is above 135 PSIG – wait for system to pull down</li> <li>Green harness not plugged in properly or securely into the back of the controller – check connections</li> <li>Cable not connected properly with the pressure transducer – check connections</li> </ul>	<ul style="list-style-type: none"> <li>Transducer cable miswired – inspect cable, replace if needed</li> <li>Damaged transducer – inspect transducer, replace if needed</li> </ul>
Controller flashes “P2” on a unit with fan cycling	<ul style="list-style-type: none"> <li>Green harness not plugged in properly or securely into the back of the controller – check connections</li> </ul>	<ul style="list-style-type: none"> <li>Transducer cable miswired – inspect cable, replace if needed</li> <li>Check condenser temperature sensor resistance values against table in AE-1376, Section 8</li> </ul>
Controller flashes “P2” on a unit without fan cycling after replacing a controller	<ul style="list-style-type: none"> <li>Controller not programmed properly – check parameters in the advanced menu</li> </ul>	
Controller flashes “P3” on a unit with DLT	<ul style="list-style-type: none"> <li>Jumper cable not plugged in properly or securely into the back of the controller – check connections</li> </ul>	<ul style="list-style-type: none"> <li>Jumper cable miswired – inspect cable, replace if needed</li> <li>Faulty DLT temperature sensor – check the discharge line temperature sensor resistance values against table in AE-1376, Section 8</li> </ul>
Controller flashes “P3” on a unit without DLT after replacing a controller	<ul style="list-style-type: none"> <li>Controller not programmed properly – check parameters in the advanced menu</li> </ul>	
Fans not running on a fan cycling unit and the fan lights are not on	<ul style="list-style-type: none"> <li>Condensing temperature is currently below the fan cut-in</li> <li>Condensing temperature sensor not properly installed – check installation</li> </ul>	<ul style="list-style-type: none"> <li>Transducer cable miswired – inspect cable, replace if needed</li> <li>Faulty temperature sensor - check condenser temperature sensor resistance values against table in AE-1376, Section 8</li> </ul>
Fans not running on a fan cycling unit and the fan lights are on	<ul style="list-style-type: none"> <li>Power cable harness not plugged in properly or securely into the back of the controller – check connections</li> </ul>	<ul style="list-style-type: none"> <li>Power cable miswired – inspect cable, replace if needed</li> <li>Electrical assembly miswired – trace wiring diagrams</li> </ul>
Controller flashes “HP” at power-up	<ul style="list-style-type: none"> <li>Jumper cable not plugged in properly or securely into the back of the controller – check connections</li> <li>High pressure switch is seeing above the cut-out pressure</li> <li>For a replacing an -00 controller, ensure that the jumper cable is the latest revision. It should have a blue wire in the harness. See replacement instructions for more details</li> </ul>	<ul style="list-style-type: none"> <li>Jumper cable miswired – inspect cable, replace if needed</li> <li>Faulty fixed Hp switch – inspect switch, replace if needed</li> </ul>
Controller flashes “HP” or “HPL”	<ul style="list-style-type: none"> <li>System operation causing high discharge pressures, check system operations</li> </ul>	<ul style="list-style-type: none"> <li>Bad high pressure switch, verify system pressure when the pressure switch trips.</li> <li>See AE-1376, Section 7.2 for more details</li> </ul>
Controller flashes “DLT” or “DLL”	<ul style="list-style-type: none"> <li>System operation causing high discharge line temperatures, check system operations</li> </ul>	<ul style="list-style-type: none"> <li>Faulty temperature sensor - check DLT sensor values against table in section 8</li> <li>See AE-1376, Section 7.1 for more details</li> </ul>
Controller flashing “HPL” or “DLL”	<ul style="list-style-type: none"> <li>System operation causing high discharge pressures (HPL) or high discharge line temperatures (DLL) repeatedly, check system operations</li> <li>To clear an “HPL” or “DLL” lockout, you can hold the Restart button for 3 seconds twice, or cycle power to the unit. If using the reset button, the alarm condition will have to clear (DLT temperature drops or Hp switch resets), and any minimum off time will need to complete (5 minutes for the fixed Hp switch)</li> </ul>	

## EmersonClimate.com/ElectronicUnitController

2013ECT-46 (9/13) Emerson is a trademark of Emerson Electric Co. ©2013 Emerson Climate Technologies, Inc. All rights reserved.

EMERSON. CONSIDER IT SOLVED.™

## WHISPERKOOL TROUBLESHOOTING GUIDE

### Unit has ice forming on the evaporator unit

Possible cause	Solution
Evaporator filter or coil is dirty	Remove the filter and wash it, then clean the coil with a vacuum. If coil is very dirty, use a spray bottle with a small amount of liquid dish detergent or coil cleaner. Spray coil, let set for five minutes, then flush with fresh water.
There is something blocking the supply and/or return air	Remove blockage
The evaporator fan is not turning on	Call a service tech to troubleshoot
The evaporator unit has not gone through its Anti-Frost sequence yet	Check the coil for surface ice. Melt with blow drier until coil is warm to the touch. Soak up water with a towel.
If evaporator unit continues to ice	Observe ice formation pattern. If only part way up the coil face, the system could be low on refrigerant. If all the way up, the coil may be dirty or airflow is blocked.

### Unit does not run/power up

Possible cause	Solution
Evaporator Unit is not plugged in	Make sure the unit is plugged into an outlet
Power switch not on	Turn unit on by pressing the power button on the control
Line voltage rating is incorrect for the system	Check line voltage to make sure it is 110V-120V
Bottle at setpoint	Lower setpoint
Thermostat not calling for cooling	Lower setpoint
Faulty thermostat or wiring	Call Customer Service at 1-800-343-9463

### Cellar temperature is too warm

Possible cause	Solution
The temperature of the room to which the condensing unit exhausts exceeds 110°F	Intake temperature must drop below 110°F
The system is undersized for the cellar	Order correct size system
There is something blocking the supply and/or return air on the evaporator unit or the condensing unit	Remove air flow obstruction
Evaporator Unit is mounted too low in the cellar	Relocate unit so the distance from the ceiling and top of the unit is no more than 18"
One or more of the fans is not turning on	Please contact the installing technician to troubleshoot
Compressor is not turning on	Please contact the installing technician to troubleshoot
Compressor keeps cycling on overload	Make sure all fans are working and there is no airflow obstruction
Poor seal around door or other areas requiring a seal (around the unit, wall joints, etc.)	Make sure there are no air gaps around the door. If door seal is damaged, replace it.
Controller set too high	Lower the setpoint
Evaporator coil is frosted or iced up	Observe ice formation pattern. If only part way up the coil face, evaporator unit could be low on refrigerant. If so, contact your installing technician to assist with troubleshooting.

### System runs constantly

Possible cause	Solution
Leaky door seal or poorly insulated cellar	Fix leaky door seal and insulate cellar in accordance with this manual (page 8).

<b>Unit leaks water</b>	
<b>Possible cause</b>	<b>Solution</b>
Evaporator unit is not level	Evaporator unit should be level on the wall to prevent leaking
Drain line clogged or kinked	Check drain line to make sure water can flow freely
Drain is clogged, preventing water from escaping	Disconnect drain and clear it out; open access door and check drain for blockage
Drain line does not have a downward slope	Fix drain line so there is a downward slope from the unit to the drain
Coil is iced, causing drain pan to freeze and water to overflow	Melt ice with blow drier. Soak up with a towel.
<b>Unit runs but does not cool</b>	
<b>Possible cause</b>	<b>Solution</b>
Lack of air flow	Make sure fan is unobstructed and that the evaporator filter, evaporator coil, and condenser coil are clean and free of debris
System undersized	Contact Customer Service at 1-800-343-9463
Compressor is overheating	Shut system off for 1 hour to allow compressor to cool. Turn back on and check for cooler airflow out. If compressor runs, check for and clean condenser coil as possible cause of compressor overheating. If problem repeats, contact you installing technician to assist with troubleshooting.
<b>Evaporator fan runs but compressor does not</b>	
<b>Possible cause</b>	<b>Solution</b>
Running an Anti-Frost Cycle	1) If the system is maintaining the correct cellar temperature and there is a dripping snowflake symbol illuminated on the display, the system is going through an Anti-Frost Cycle. No action is required. 2) If the system is not maintaining the correct cellar temperature, this may be due to a dirty evaporator filter or coil. 3) Call the installing technician to troubleshoot, as the system may be low on charge or require an adjustment to the TXV.
Compressor and/or starting components faulty	Please contact the installing technician to troubleshoot
System may be performing the WHM function	Allow cooling system to revert back to cooling mode
Compressor may have overheated	Shut system off for 1 hour to allow compressor to cool. Turn back on and check for cooler airflow out. If compressor runs, check for and clean condenser coil as possible cause of compressor overheating. If problem repeats, contact your installing technician to assist with troubleshooting.
<b>Compressor runs but evaporator fan does not</b>	
<b>Possible cause</b>	<b>Solution</b>
Faulty fan motor	Please contact the installing technician to troubleshoot
Faulty controller	Please contact the installing technician to troubleshoot
<b>Compressor short cycles</b>	
<b>Possible cause</b>	<b>Solution</b>
Evaporator unit blows on bottle probe	Move bottle probe to a more central location
System low on refrigerant charge	Please contact the installing technician to troubleshoot
Condensing fan motor/capacitor faulty	Please contact the installing technician to troubleshoot
Compressor and /or starting components faulty	Please contact the installing technician to troubleshoot
<b>Humidity in cellar too low</b>	
<b>Possible cause</b>	<b>Solution</b>
Not enough moisture	Raise the "fan on" setting to increase the humidity level

## MAINTENANCE SCHEDULE

<b>Monthly</b>	<ol style="list-style-type: none"><li>1. Check for debris surrounding condensing unit (leaves, branches, trash, etc); remove all obstructions</li><li>2. Check for unusual noise or vibration</li><li>3. Check the drain line to see if it is above the waterline (if draining into a vessel)</li></ol>
<b>Quarterly</b>	<ol style="list-style-type: none"><li>1. Use a vacuum with brush attachment to clean the evaporator coil; be careful not to crush coil fins when cleaning</li><li>2. Remove the evaporator filter and clean with warm water</li><li>3. Ensure the condensing unit is free of debris and dust</li><li>4. Have a certified HVAC-R technician service the condensing unit and clean the condenser coil</li></ol>
<b>Annually</b>	<ol style="list-style-type: none"><li>1. Inspect for corrosion</li><li>2. Check wiring connections and integrity of cords</li><li>3. Pour a 50/50 bleach solution into the drain line every spring</li></ol>

## TECHNICAL ASSISTANCE

WhisperKOOL Customer Service is available Monday through Friday from 6:00 a.m. to 4:00 p.m. Pacific Standard Time.

The appointed customer service representative will be able to assist you with your questions and warranty information more effectively if you provide them with the following:

- The model and serial number of your WhisperKOOL systems.
- Location of unit and installation details, such as ventilation, ducting, construction of your wine cellar, and room size.
- Photos of the cellar and installation location may be needed.

### Contact WhisperKOOL Customer Service

1738 E. Alpine Ave  
Stockton, CA, 95205  
[www.whisperkool.com](http://www.whisperkool.com)

**Email:** [support@whisperkool.com](mailto:support@whisperkool.com)

**Phone:** 209-466-9463

**US Toll Free:** 1-800-343-9463

**Fax:** 209-466-4606

Visit [www.emersonclimate.com/electronicunitcontroller](http://www.emersonclimate.com/electronicunitcontroller) for online brochures, bulletins, instruction videos, and general product information.

**Download the Copeland Mobile App on your mobile device for additional troubleshooting and technical information.**



## ACCESSORIES FOR COOLING UNITS

WhisperKOOL offers accessories to enhance and customize your wine cooling unit:

### Exterior Housing

Protects the condensing unit from the weather elements when the unit is located outside.

### Condensate Pump Kit

The condensate pump kit is designed as an automatic condensate removal pump for water dripping out of our Evaporator Unit's (Fan Coil Unit's) drain line. The pump is controlled by a float/switch mechanism that turns the pump on when approximately 2¼" of water collects in the tank, and automatically switches off when the tank drains to approximately 1¼". The condensate pump kit allows the excess condensate to be pumped up to 20 ft. away from the unit.

**Accessories can be purchased at [www.whisperkool.com](http://www.whisperkool.com)**



**WhisperKOOL Product Terms and Conditions**  
**Including Product Limited Warranty And Product Installation Requirements**  
**For WhisperKOOL Split System Series**

ATTENTION: PLEASE READ THESE TERMS OF USE CAREFULLY BEFORE INSTALLING YOUR WHISPERKOOL COOLING SYSTEM. INSTALLING YOUR WHISPERKOOL COOLING SYSTEM INDICATES THAT YOU ACCEPT AND AGREE TO EACH OF THE TERMS AND CONDITIONS SET FORTH HEREIN ("TERMS OF USE"). IF YOU DO NOT ACCEPT THESE TERMS OF USE, YOU RISK VOIDING YOUR WARRANTY AND ASSUMING ADDITIONAL REPAIR AND REPLACEMENT COSTS.

**1. Purchase of a WhisperKOOL Cooling System assumes that the Purchaser ("End User") fully accepts and agrees to the Terms and Conditions set forth in this document. The Terms and Conditions of Sale and Owner's Manual are shipped with each unit and, if another copy is needed, replacement copies can be downloaded from the company website (whisperkool.com) or by contacting WhisperKOOL directly for a new copy. WhisperKOOL reserves the right, in its sole discretion, to change its Terms and Conditions at any time, for any reason, without notice.**

**2. WhisperKOOL Product Installation and Limited Warranty**

- A. Purchaser of the product must arrange for the product to be installed by a certified HVAC/R technician in accordance with procedures set forth by WhisperKOOL and described in the WhisperKOOL Owner's Manual.
- B. The HVAC/R technician installing the product must complete the designated portion of the Split Startup Checklist and provide licensing or certification identification number information to assist in the warranty registration process.
- C. Purchaser must return the completed Split Startup Checklist to WhisperKOOL within thirty (30) days of installation of Product. The Split Startup Checklist must be approved by WhisperKOOL to activate the Limited Warranty. If the Split Startup Checklist is approved, Purchaser will be sent activation approval documents and will start receiving the benefits of the Limited Warranty throughout the warranty period. If the Split Startup Checklist is incomplete, Purchaser will be informed they have five days to complete the Split Startup Checklist and re-submit to WhisperKOOL. The Split Startup Checklist will be reviewed again, and if denied, Purchaser will be informed that they have 10 business days for corrective action. Failure to register the Product may result in loss of warranty.
- D. Purchaser is responsible for the full costs of installation and any additional parts required for the proper and complete installation of the product.
- E. For Split Systems returned to WhisperKOOL in accordance with the terms and conditions of the Limited Warranty, WhisperKOOL warrants against defects in material and workmanship as follows:
  1. **LABOR** — For a period of two (2) years commencing on the date of purchase, WhisperKOOL will, at its option and discretion, reimburse up to \$250 to the End User for cost incurred for servicing, repairing, removing or installing warranty parts. Invoice for service must be forwarded to WhisperKOOL for assessment and processing. The Split System warranty is invalid if there is attempted repair by anyone other than an HVAC/R technician approved by WhisperKOOL to service the Product.
  2. **PARTS** — For a period of two (2) years commencing on the date of purchase, WhisperKOOL will supply, at no charge, new or rebuilt replacement parts in exchange for defective parts. Replacement parts are warranted only for the remainder of the original warranty period.
  3. **FREIGHT** — For a period of two (2) years commencing on the date of purchase, if after WhisperKOOL approved evaluation the original Product failure is determined to be the cause of a manufacturers defect, and not the cause of an installation error or other cause, WhisperKOOL will cover at its option, freight for the replacement parts or Product.

**The following part or cause of failure is not the responsibility of WhisperKOOL:**

- Improper voltage supply
- Line set with screw connectors (high end and low end)
- Leaks found at the braze points when performing pressure check
- Unit that has been charged incorrectly

- Incorrect tubing diameter used on line set
- A unit that has been wired incorrectly
- Valve stem on condenser side
- Improper installation of P-Trap
- Lack of P-Trap (if required)
- Condensers that are installed outdoors or in elements that would affect operation without proper cover or housing. (Housing is available from Manufacturer).

**Product Warranty Limitations and Exclusions.**

1. This limited warranty does not cover cosmetic damage caused during installation, damage due to acts of God, commercial use, accident, misuse, abuse, negligence, or modification to any part of the Product. Delivery and installation of the Product, any additional parts required, as well as removal of the Product if warranty work is required, are all at the sole cost, risk and obligation of the End User.
2. This limited warranty does not cover damage due to improper installation or operation or lack of proper maintenance of the Product, connection of the Product to improper voltage supply, or attempted repair of the Product by anyone other than a technician approved by WhisperKOOL to service the Product.
3. This limited warranty does not cover any Product sold "AS IS" or "WITH ALL FAULTS."
4. Product that has been replaced during warranty period does not extend the warranty period past the original date of purchase.
5. This limited warranty is valid only in the continental United States. Sales elsewhere are excluded from this warranty.
6. Proof of purchase of the Product in the form of a bill of sale, receipted invoice or serial number, which is evidence that the Product is within the Limited Warranty Period, must be presented by the End User to WhisperKOOL in order to obtain limited warranty service.
7. This limited warranty is void if the factory applied serial number has been altered or removed from the Product.
8. This limited warranty is voided if installed in an enclosure of insufficient design that does not follow the Product installation requirements stated herein and in the owner's manual.
9. Removing the rivets from the Product's unit housing without prior authorization from WhisperKOOL voids this limited warranty.
10. The End User must first contact WhisperKOOL Customer Service by telephone (at 1-800-343-9463) prior to attempting service on any Product still under the limited warranty; else the limited warranty is voided.
11. This limited warranty does not cover Product being concealed by, but not limited to, vegetation, fabric, shelving, mud, snow, or dirt. Product must not be painted or limited warranty will be void.
12. This limited warranty does not cover exposure to corroding environments such as, but not limited to, petroleum and gasoline products, cleaning solvents, caustic pool chemicals, and marine air.
13. This limited warranty does not cover any cause not relating to Product defect.
14. THE REPAIR OR REPLACEMENT OF THE PRODUCT AS PROVIDED UNDER THIS LIMITED WARRANTY IS THE EXCLUSIVE REMEDY OF YOU, THE END USER, AS WELL AS ANYONE ELSE IN THE CHAIN OF TITLE OF THE PRODUCT, DOES NOT START A NEW LIMITED WARRANTY TIME PERIOD, AND IS IN LIEU OF ALL OTHER WARRANTIES (EXPRESS OR IMPLIED) WITH REGARD TO THE PRODUCT. IN NO EVENT SHALL WHISPERKOOL BE LIABLE FOR INCIDENTAL, CONSEQUENTIAL, SPECIAL OR CONTINGENT DAMAGES FOR BREACH OF ANY EXPRESS OR IMPLIED WARRANTY ON THIS PRODUCT. THE IMPLIED WARRANTIES OF MERCHANTABILITY
15. AND FITNESS FOR A PARTICULAR PURPOSE ARE HEREBY EXPRESSLY DISCLAIMED. Some states do not allow the exclusion or limitation of incidental or consequential damages, or allow limitations on how long an implied warranty lasts, so the above limitations or exclusions may not apply to you. This limited warranty gives you specific legal rights, and you may have other rights, which vary from state to state.
16. Failure of the End User to comply with all of the Product Installation Requirements, Maintenance Requirements and End User Requirements may, at WhisperKOOL's sole discretion, void this limited warranty.
17. No one has any authority to add to or vary the limited warranty on this Product.

### 3. Maintenance Requirements

The End User is responsible for checking the coils on the condenser unit and vacuuming them every three months to maintain them free of debris. It is the End User's responsibility to clean off any accumulated dust, lint, or other debris from the front and rear intake grills; failure to do this on a regular basis will restrict the airflow and may affect the Product's ability to function properly. Periodically cleaning the Product's vents will help assure maximum cooling efficiency. The drain tube must also be checked and kept clean and free of debris and mold to maintain proper performance.

Mold is a natural living organism in the environment. It exists in the air in the form of microscopic spores that move in and out of buildings through doors, windows, vents, HVAC systems and anywhere else that air enters. Once it is discovered, mold must be addressed quickly and appropriately. Delayed or improper treatment of mold issues can result in costly and reoccurring repairs. If the End User suspects a mold problem, it is always best to hire a qualified and experienced mold remediation specialist.

### 4. Additional End User Costs And Responsibilities

#### Terms and conditions for replacing the Product that is being evaluated for limited warranty.

1. After evaluation by a certified HVAC/R technician and the Product is found to be irreparable in the field, contact WhisperKOOL Customer Service to arrange for replacement under the warranty guidelines. When a claim for warranty is submitted for a condenser skid, the End User must purchase a new condenser skid from WhisperKOOL at retail price. Upon installation of the new condenser skid by a certified HVAC/R Technician, the HVAC/R Technician must complete the Installation Checklist and End User must submit the Installation Checklist to WhisperKOOL Customer Service for approval. The original condenser skid must be returned within 21 days to WhisperKOOL for failure analysis. If the Installation Checklist is approved and the failure is evaluated as defective and not installation error or other reason, the End User will be refunded for the cost of the replacement skid.
2. If the Product failure is evaluated and it is determined that it is an installation error or other reason, all costs, including shipping will be the responsibility of the End User.

The following items are not covered under any warranty and are the sole responsibility of the End User:

- A. End Users should satisfy themselves that the Product they are purchasing is suitable for their particular needs and requirements, and thus no responsibility will be placed with WhisperKOOL for the End User's decisions in this regard.
- B. End Users must assure that the product is installed by a certified HVAC/R technician. Failure to do so will result in Voiding the Limited Warranty.
- C. It is the End User's responsibility to secure safe haven/storage for ANY AND ALL items that are being kept and stored in the End User's wine cellar, including any Product. WhisperKOOL takes no responsibility for the safety and preservation of the aforementioned items in the event that the environment becomes unsuitable to maintain a proper storage environment.
- D. End User is responsible for initial installation costs, including, but not limited to, labor costs and the cost of any additional parts necessary to complete the installation.
- E. End User is responsible for all costs incurred for the installation and/or removal of the Product, or any part thereof, unless such cost has been agreed by WhisperKOOL to be a warranty repair prior to the work being performed.

### 5. Sales and Use Tax

WhisperKOOL only collects California sales tax for orders shipped within the State of California; WhisperKOOL does not collect sales tax for orders shipped to other states. However, the Purchaser and the End User may be liable to the taxing authority in their state for sales tax and/or use tax on the Product. The Purchaser and the End User should each check with their state's taxing authority for sales and use tax regulations.

### 6. Customer Service and Troubleshooting

WhisperKOOL's customer service department is available to answer any questions or inquiries for End Users regarding a WhisperKOOL Product, as well as to assist in performing basic troubleshooting, Monday through Friday, from 6:00 a.m. to 4:00 p.m. PST, at telephone number 1-800-343-9463. WhisperKOOL reserves the right to have a certified, WhisperKOOL-approved, HVAC/R technician go on site and inspect the product if the initial trouble shooting warrants further investigation. WhisperKOOL Corporation is located at 1738 East Alpine Avenue, Stockton, California 95205.

## 7. Request for Product Evaluation and Repair Under Warranty

**SPLIT SYSTEM FIELD SERVICE WARRANTY POLICY:** This Policy is to clarify what falls under Warranty Service and what becomes the responsibility of the Owner. WhisperKOOL (“manufacturer”) strives to provide our customers with a superior Product and we back our Product with a Two Year Limited Warranty. Please review the WhisperKOOL Product Terms and Conditions including Product Limited Warranty and Product Installation Requirements to ensure you have a complete understanding of our Policy and coverage of your Split System.

**ARBITRATION:** Any disputes arising out of or in connection with the installation and warranty of the Split System shall be referred to and finally resolved by a WhisperKOOL approved Independent Certified HVAC/R Technician. The evaluation of the Technician on all issues or matters of identifying the responsible party (WhisperKOOL or Installing Technician) shall be determined in a written report. This report will be made available to all concerned parties. If discovered under warranty, WhisperKOOL will assume the financial responsibility under their warranty guidelines. If the report finds the Owner’s Installer as the responsible party, WhisperKOOL will provide all documentation to the customer to substantiate the findings. This will include the Invoice from the Independent Certified HVAC/R Technician and the written report of the findings. The Owner will become responsible for payment directly to WhisperKOOL for all charges incurred for repairs (labor, parts and shipping costs) on the Split System.

## 8. Miscellaneous Terms and Conditions

- A. Return Policy. All return inquiries must be made within thirty (30) calendar days of the original purchase of a Product and are subject to a twenty five percent (25%) restocking fee. Shipping costs are not refundable and the Purchaser is responsible for all return shipping costs (including customs fees and duties, if applicable).
- B. Security Interest. WhisperKOOL retains a security interest in each Product until payment in full.
- C. Construction and Severability. Every provision of these Terms and Conditions shall be construed, to the extent possible, so as to be valid and enforceable. If any provision of these Terms and Conditions is held by a court of competent jurisdiction to be invalid, illegal or otherwise unenforceable, such provision will, to the extent so held, be deemed severed from the contract of sale between Purchaser and WhisperKOOL, and all of the other non-severed provisions will remain in full force and effect.
- D. Governing Law/Choice of Forum. The laws of the State of California (without regard for conflicts of law) shall govern the construction and enforcement of the these Terms and Conditions of Sale (Sections 1 through 9 inclusive, including Product Limited Warranty And Product Installation Requirements), and further these Terms and Conditions of Sale shall be interpreted as through drafted jointly by WhisperKOOL and Purchaser. Any dispute will be resolved by the courts in and for the County of San Joaquin, State of California, and all parties, WhisperKOOL, Purchaser and End User, hereby irrevocably submit to the personal jurisdiction of such courts for that purpose. No waiver by WhisperKOOL of any breach or default of the contract of sale (including these Terms and Conditions of Sale) concerning a Product will be deemed to be a waiver of any preceding or subsequent breach or default.
- E. Correction of Errors and Inaccuracies. These Terms and Conditions may contain typographical errors or other errors or inaccuracies. WhisperKOOL reserves the right to correct any errors, inaccuracies or omissions, and to change or update these Terms and Conditions, at any time without prior notice.

## 9. Questions, Additional Information And Technical Assistance

- A. Questions. If you have any questions regarding these Terms and Conditions or wish to obtain additional information, contact us via phone at 1-800-343-9463 or please send a letter via U.S. Mail to:

Customer Service  
WhisperKOOL Corporation  
1738 E Alpine Ave  
Stockton, CA 95205

E-mail: [support@whisperkool.com](mailto:support@whisperkool.com)  
Web: [www.whisperkool.com](http://www.whisperkool.com)

- B. Technical Assistance. WhisperKOOL Customer Service is available Monday through Friday from 6:00 a.m. to 4:00 p.m. PST. The Customer Service representative will be able to assist you with your questions and warranty information more effectively if you provide them with the following:
  - 1. The model and serial number of your WhisperKOOL UNIT.
  - 2. The location of the system and installation details, such as ventilation, construction of your wine cellar, and room size.

**Model** \_\_\_\_\_ **Serial Number** \_\_\_\_ \_\_\_\_ \_\_\_\_ \_\_\_\_ \_\_\_\_

**Installed by** \_\_\_\_\_ **Date** \_\_\_\_\_

*Whisper***KOOL™**

WhisperKOOL  
1738 E. Alpine Ave  
Stockton, CA 95205  
1(800) 343-9463  
[www.whisperkool.com](http://www.whisperkool.com)